

Pioneer

Operating Instructions

ELITE

audio/video multi-channel receiver

VSX-53

VSX-52

IMPORTANT



The lightning flash with arrowhead symbol, within an equilateral triangle, is intended to alert the user to the presence of uninsulated "dangerous voltage" within the product's enclosure that may be of sufficient magnitude to constitute a risk of electric shock to persons.

CAUTION

**RISK OF ELECTRIC SHOCK
DO NOT OPEN**

CAUTION:
TO PREVENT THE RISK OF ELECTRIC SHOCK, DO NOT REMOVE COVER (OR BACK). NO USER-SERVICEABLE PARTS INSIDE. REFER SERVICING TO QUALIFIED SERVICE PERSONNEL.



The exclamation point within an equilateral triangle is intended to alert the user to the presence of important operating and maintenance (servicing) instructions in the literature accompanying the appliance.

D3-4-2-1-1_A1_En

WARNING

This equipment is not waterproof. To prevent a fire or shock hazard, do not place any container filled with liquid near this equipment (such as a vase or flower pot) or expose it to dripping, splashing, rain or moisture.

D3-4-2-1-3_A1_En

WARNING

Before plugging in for the first time, read the following section carefully.

The voltage of the available power supply differs according to country or region. Be sure that the power supply voltage of the area where this unit will be used meets the required voltage (e.g., 230 V or 120 V) written on the rear panel.

D3-4-2-1-4*_A1_En

VENTILATION CAUTION

When installing this unit, make sure to leave space around the unit for ventilation to improve heat radiation (at least 40 cm at top, 10 cm at rear, and 20 cm at each side).

WARNING

Slots and openings in the cabinet are provided for ventilation to ensure reliable operation of the product, and to protect it from overheating. To prevent fire hazard, the openings should never be blocked or covered with items (such as newspapers, table-cloths, curtains) or by operating the equipment on thick carpet or a bed.

D3-4-2-1-7b*_A1_En

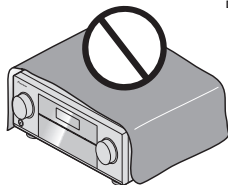

D3-4-2-2-2a*_A1_En

WARNING

To prevent a fire hazard, do not place any naked flame sources (such as a lighted candle) on the equipment.

D3-4-2-1-7a_A1_En

Operating Environment

Operating environment temperature and humidity: +5 °C to +35 °C (+41 °F to +95 °F); less than 85 %RH (cooling vents not blocked)

Do not install this unit in a poorly ventilated area, or in locations exposed to high humidity or direct sunlight (or strong artificial light)

D3-4-2-1-7c*_A1_En

If the AC plug of this unit does not match the AC outlet you want to use, the plug must be removed and appropriate one fitted. Replacement and mounting of an AC plug on the power supply cord of this unit should be performed only by qualified service personnel. If connected to an AC outlet, the cut-off plug can cause severe electrical shock. Make sure it is properly disposed of after removal.

The equipment should be disconnected by removing the mains plug from the wall socket when left unused for a long period of time (for example, when on vacation).

D3-4-2-2-1a_A1_En

CAUTION

The **⏻** STANDBY/ON switch on this unit will not completely shut off all power from the AC outlet. Since the power cord serves as the main disconnect device for the unit, you will need to unplug it from the AC outlet to shut down all power. Therefore, make sure the unit has been installed so that the power cord can be easily unplugged from the AC outlet in case of an accident. To avoid fire hazard, the power cord should also be unplugged from the AC outlet when left unused for a long period of time (for example, when on vacation).

D3-4-2-2-2a*_A1_En

IMPORTANT SAFETY INSTRUCTIONS

- 1) Read these instructions.
- 2) Keep these instructions.
- 3) Heed all warnings.
- 4) Follow all instructions.
- 5) Do not use this apparatus near water.
- 6) Clean only with dry cloth.
- 7) Do not block any ventilation openings. Install in accordance with the manufacturer's instructions.
- 8) Do not install near any heat sources such as radiators, heat registers, stoves, or other apparatus (including amplifiers) that produce heat.
- 9) Do not defeat the safety purpose of the polarized or grounding-type plug. A polarized plug has two blades with one wider than the other. A grounding type plug has two blades and a third grounding prong. The wide blade or the third prong are provided for your safety. If the provided plug does not fit into your outlet, consult an electrician for replacement of the obsolete outlet.
- 10) Protect the power cord from being walked on or pinched particularly at plugs, convenience receptacles, and the point where they exit from the apparatus.
- 11) Only use attachments/accessories specified by the manufacturer.
- 12) Use only with the cart, stand, tripod, bracket, or table specified by the manufacturer, or sold with the apparatus. When a cart is used, use caution when moving the cart/apparatus combination to avoid injury from tip-over.
- 13) Unplug this apparatus during lightning storms or when unused for long periods of time.
- 14) Refer all servicing to qualified service personnel. Servicing is required when the apparatus has been damaged in any way, such as power-supply cord or plug is damaged, liquid has been spilled or objects have fallen into the apparatus, the apparatus has been exposed to rain or moisture, does not operate normally, or has been dropped.



D3-7-13-69_En

NOTE:

This equipment has been tested and found to comply with the limits for a Class B digital device, pursuant to Part 15 of the FCC Rules. These limits are designed to provide reasonable protection against harmful interference in a residential installation. This equipment generates, uses, and can radiate radio frequency energy and, if not installed and used in accordance with the instructions, may cause harmful interference to radio communications. However, there is no guarantee that interference will not occur in a particular installation. If this equipment does cause harmful interference to radio or television reception, which can be determined by turning the equipment off and on, the user is encouraged to try to correct the interference by one or more of the following measures:

- Reorient or relocate the receiving antenna.
- Increase the separation between the equipment and receiver.
- Connect the equipment into an outlet on a circuit different from that to which the receiver is connected.
- Consult the dealer or an experienced radio/TV technician for help.

D8-10-1-2_A1_En

Caution

To prevent fire hazard, the Class 2 Wiring Cable should be used for connection with speaker, and should be routed away from hazards to avoid damage to the insulation of the cable.

D3-7-13-67*_A1_En

Information to User

Alterations or modifications carried out without appropriate authorization may invalidate the user's right to operate the equipment.

D8-10-2_A1_En

WARNING: Handling the cord on this product or cords associated with accessories sold with the product may expose you to chemicals listed on proposition 65 known to the State of California and other governmental entities to cause cancer and birth defect or other reproductive harm.

Wash hands after handling.

D36-P5_B1_En

IMPORTANT NOTICE

THE MODEL NUMBER AND SERIAL NUMBER OF THIS EQUIPMENT ARE ON THE REAR OR BOTTOM. RECORD THESE NUMBERS ON YOUR ENCLOSED WARRANTY CARD AND KEEP IN A SAFE PLACE FOR FUTURE REFERENCE.

D36-AP9-1_A1_En

CAUTION

This product satisfies FCC regulations when shielded cables and connectors are used to connect the unit to other equipment. To prevent electromagnetic interference with electric appliances such as radios and televisions, use shielded cables and connectors for connections.

D8-10-3a_A1_En

This product is for general household purposes. Any failure due to use for other than household purposes (such as long-term use for business purposes in a restaurant or use in a car or ship) and which requires repair will be charged for even during the warranty period.

K041_A1_En

This Class B digital apparatus complies with Canadian ICES-003.

D8-10-1-3_A1_En

**CAUTION:
HOT SURFACE. DO NOT TOUCH.**

The top surface over the internal heatsink may become hot when operating this product continuously.

The Safety of Your Ears is in Your Hands

Get the most out of your equipment by playing it at a safe level – a level that lets the sound come through clearly without annoying blaring or distortion and, most importantly, without affecting your sensitive hearing. Sound can be deceiving. Over time, your hearing "comfort level" adapts to higher volumes of sound, so what sounds "normal" can actually be loud and harmful to your hearing. Guard against this by setting your equipment at a safe level BEFORE your hearing adapts.

ESTABLISH A SAFE LEVEL:

- Set your volume control at a low setting.
- Slowly increase the sound until you can hear it comfortably and clearly, without distortion.
- Once you have established a comfortable sound level, set the dial and leave it there.

BE SURE TO OBSERVE THE FOLLOWING GUIDELINES:

- Do not turn up the volume so high that you can't hear what's around you.
- Use caution or temporarily discontinue use in potentially hazardous situations.
- Do not use headphones while operating a motorized vehicle; the use of headphones may create a traffic hazard and is illegal in many areas.

S001a_A1_En

Thank you for buying this Pioneer product. Please read through these operating instructions so you will know how to operate your model properly. After you have finished reading the instructions, put them away in a safe place for future reference.

Contents

01 Before you start

Our philosophy.....	6
Features.....	6
Checking what's in the box.....	6
Installing the receiver.....	6
Loading the batteries.....	6
Operating range of remote control unit.....	7
About using AVNavigator (included CD-ROM).....	7

02 Controls and displays

Remote control.....	8
Display.....	9
Front panel.....	10

03 Connecting your equipment

Connecting your equipment.....	11
Rear panel.....	11
Determining the speakers' application.....	12
Placing the speakers.....	13
Connecting the speakers.....	13
Installing your speaker system.....	14
Selecting the Speaker system.....	15
About the audio connection.....	16
About the video converter.....	16
About HDMI.....	16
Connecting your TV and playback components.....	17
Connecting an HDD/DVD recorder, BD recorder and other video sources.....	19
Connecting a satellite/cable receiver or other set-top box.....	19
Connecting other audio components.....	20

Connecting additional amplifiers.....	20
Connecting AM/FM antennas.....	21
MULTI-ZONE setup.....	21
Connecting a SiriusConnect Tuner.....	22
Connecting to the network through LAN interface.....	22
Connecting optional Bluetooth ADAPTER.....	22
Connecting an iPod.....	23
Connecting a USB device.....	23
Connecting an HDMI-equipped component to the front panel input.....	23
Connecting to a wireless LAN.....	23
Connecting an IR receiver.....	23
Operating other Pioneer components with this unit's sensor.....	24
Switching components on and off using the 12 volt trigger.....	24
Plugging in the receiver.....	25

04 Basic Setup

Switching the speaker impedance.....	26
Changing the OSD display language (OSD Language).....	26
Automatically conducting optimum sound tuning (Full Auto MCACC).....	26
The Input Setup menu.....	28
Operation Mode Setup.....	28

05 Basic playback

Playing a source.....	30
Playing an iPod.....	30
Playing a USB device.....	31
Listening to the radio.....	33
Listening to Satellite Radio.....	33
Bluetooth ADAPTER for Wireless Enjoyment of Music.....	35

06 Listening to your system

Enjoying various types of playback using the listening modes.....	37
Selecting MCACC presets.....	39
Choosing the input signal.....	39
Better sound using Phase Control.....	39
Better sound using Phase Control and Full Band Phase Control.....	39

07 Playback with HOME MEDIA GALLERY inputs

Enjoying the Home Media Gallery.....	41
Features of Home Media Gallery.....	41
Introduction.....	41
Playback with Home Media Gallery.....	42
Advanced operations for Internet radio.....	43
Checking about the Accounts.....	43
About network playback.....	44
About playable file formats.....	45

08 Control with HDMI function

About the Control with HDMI function.....	47
Making Control with HDMI connections.....	47
HDMI Setup.....	47
Before using synchronization.....	48
About synchronized operations.....	48
Setting the PQLS function.....	48
Cautions on the Control with HDMI function.....	49

09 Using other functions

Setting the Audio options.....	50
Setting the Video options.....	52
Switching the speaker terminals.....	53
Using the MULTI-ZONE controls.....	53
Making an audio or a video recording.....	54
Reducing the level of an analog signal.....	54
Using the sleep timer.....	54
Dimming the display.....	54
Switching the HDMI output.....	54
Checking your system settings.....	55
Resetting the system.....	55

10 Controlling the rest of your system

About the Remote Setup menu.....	56
Operating multiple receivers.....	56
Setting the remote to control other components.....	56
Selecting preset codes directly.....	56
Programming signals from other remote controls.....	57
Erasing one of the remote control button settings.....	57
Erasing all learnt settings that are in one input function.....	57

Direct function.....	57
Setting the backlight mode.....	58
Multi Operation and System Off.....	58
Resetting the remote control settings.....	59
Controlling components.....	59

11 The Advanced MCACC menu

Making receiver settings from the Advanced MCACC menu.....	62
Automatic MCACC (Expert).....	62
Manual MCACC setup.....	64
Checking MCACC Data.....	66
Data Management.....	67

12 The System Setup and Other Setup menus

Making receiver settings from the System Setup menu.....	69
Manual speaker setup.....	69
Network Setup menu.....	71
Checking the Network Information.....	73
The Other Setup menu.....	73

13 Additional information

Troubleshooting 1.....	76
Troubleshooting 2.....	82
Troubleshooting of wireless LAN.....	85
About status messages.....	86
Speaker Setting Guide.....	86
Important information regarding the HDMI connection.....	87
Cleaning the unit.....	87
Surround sound formats.....	88
About THX.....	88
About iPod.....	89
About SIRIUS.....	89
About FLAC.....	89
Auto Surround, ALC and Stream Direct with different input signal formats.....	90
Glossary.....	91
Features index.....	94
Specifications.....	95
Preset code list.....	96

Flow of settings on the receiver

Flow for connecting and setting the receiver

The unit is a full-fledged AV receiver equipped with an abundance of functions and terminals. It can be used easily after following the procedure below to make the connections and settings.

Required setting item: 1, 2, 3, 4, 6, 8, 10

Setting to be made as necessary: 5, 7, 9, 11, 12, 13, 14



Important

The receiver's initial settings can be made on the computer using **Wiring Navi** on the AVNavigator CD-ROM included with the receiver. In this case, virtually the same connections and settings as in steps 2, 3, 4, 6, 7, 8 and 9 can be made interactively. For instructions on using AVNavigator, see *About using AVNavigator (included CD-ROM)* on page 7.

1 Before you start

- *Checking what's in the box* on page 6
- *Loading the batteries* on page 6



2 Determining the speakers' application (page 12)

- 7.2 channel surround system (Front height)
- 7.2 channel surround system (Front wide)
- 7.2 channel surround system & Speaker B connection
- 5.2 channel surround system & Front Bi-amping connection (High quality surround)
- 5.2 channel surround system & ZONE 2 connection (Multi Zone)



3 Connecting the speakers

- *Placing the speakers* on page 13
- *Connecting the speakers* on page 13
- *Installing your speaker system* on page 14
- *Bi-amping your speakers* on page 15



4 Connecting the components

- *About the audio connection* on page 16
- *About the video converter* on page 16
- *Connecting your TV and playback components* on page 17
- *Connecting AM/FM antennas* on page 21
- *Plugging in the receiver* on page 25



5 Switching the speaker impedance (page 26)

(Only if the impedance of the connected speakers is 6 Ω to 8 Ω)



6 Power On



7 Changing the OSD display language (OSD Language) (page 26)



8 MCACC speaker settings

- *Automatically conducting optimum sound tuning (Full Auto MCACC)* on page 26



9 The Input Setup menu (page 28)

(When using connections other than the recommended connections)



10 Basic playback (page 30)



11 Switching the HDMI output (page 54)

VSX-53 only



12 Adjusting the sound and picture quality as desired

- Using the various listening modes (page 37)
- Better sound using Phase Control (page 39)
- Better sound using Phase Control and Full Band Phase Control (VSX-53 only) (page 39)
- Measuring the all EQ type (SYMMETRY/ALL CH ADJ/FRONT ALIGN) (page 62)
- Changing the channel level while listening (page 70)
- Switching on/off the Acoustic Calibration EQ, Auto Sound Retriever or Dialog Enhancement (page 50)
- Setting the PQLS function (page 48)
- Setting the Audio options (page 50)
- Setting the Video options (page 52)



13 Other optional adjustments and settings

- Control with HDMI function (page 47)
- The Advanced MCACC menu (page 62)
- The System Setup and Other Setup menus (page 69)



14 Making maximum use of the remote control

- Operating multiple receivers (page 56)
- Setting the remote to control other components (page 56)

Before you start

Our philosophy

Pioneer is dedicated to making your home theater listening experience as close as possible to the vision of the moviemakers and mastering engineer when they created the original soundtrack. We do this by focusing on three important steps:

- 1 **Designing with carefully selected components so as to transmit the original soundtrack accurately**
- 2 **Allowing for customized acoustic calibration according to any listening area**
- 3 **Tuning that transmits soul**

Features

● HDMI (3D, Audio Return Channel)

A compatible component is required to use the above function.

● HOME MEDIA GALLERY

This receiver can play back contents stored on your computer when your computer is connected to the LAN terminal of this receiver.

● About operation of the receiver with a mobile terminal (iPod, iPhone, etc.)

The receiver can be controlled from the mobile terminal by installing a special application on the mobile terminal. For details, see the product information on the Pioneer website.

This special application may be changed or discontinued without notice.

● Remote operation on an iPod touch/iPhone/iPad

Operation via LAN is possible from an iPod touch, iPhone or iPad by downloading a Pioneer original application (iControlAV2) from the iTunes Store.

● AVNavigator

The CD-ROM (AVNavigator) included with this unit provides a variety of functions, such as **Wiring Navi** with a guide for connecting the unit and setting up from the computer and an **Interactive Manual** for operating the unit while reading the manual.

● PQLS

Jitterless high quality playback is possible by connecting a PQLS-compatible player with HDMI connections.

● iPod playback

Your iPod can be connected to the receiver's USB terminal to play the music/video files on the iPod.

Also, the iPod is charged when it is connected to the receiver.

● Advanced Direct Energy design

This receiver offers a new advancement in discrete design unique to Pioneer for high-power drivability, low distortion and stable imaging.

● Dolby Pro Logic IIz compatible

Adding a pair of speakers above the front left and right speakers adds expressiveness in the vertical direction to the previous horizontally-oriented sound field. The height channel strengthens the sound field's sense of three-dimensionality and air, producing presence and expansion.

● Internet Radio

By connecting this receiver to the network via the LAN terminal, you can listen to Internet radio stations.

● SIRIUS Ready

With the SIRIUS Radio terminal, you'll be up and running in no time.

● Bluetooth compatible

Using the *Bluetooth* ADAPTER (AS-BT100 or AS-BT200) lets you enjoy music files on an iPhone or other Bluetooth wireless technology device wirelessly.

● Auto Sound Retriever

The Auto Sound Retriever feature employs DSP technology to restore sound pressure and smooth jagged artifacts left over after compression.

● Easy setup using Advanced MCACC

The Auto MCACC Setup provides a quick but accurate surround sound setup, which includes the advanced features of Professional Acoustic Calibration EQ.

Checking what's in the box

Please check that you've received the following supplied accessories:

- Setup microphone (cable: 5 m (16.4 ft.))
- Remote control unit
- AAA size IEC R03 dry cell batteries (to confirm system operation) x2
- AM loop antenna
- FM wire antenna
- iPod cable
- Power cord
- CD-ROM (AVNavigator)
- Warranty card
- These operating instructions

Installing the receiver

- When installing this unit, make sure to put it on a level and stable surface.
- Don't install it on the following places:
 - on a color TV (the screen may distort)
 - near a cassette deck (or close to a device that gives off a magnetic field). This may interfere with the sound.

- in direct sunlight
- in damp or wet areas
- in extremely hot or cold areas
- in places where there is vibration or other movement
- in places that are very dusty
- in places that have hot fumes or oils (such as a kitchen)
- Do not touch this receiver's bottom panel while the power is on or just after it is turned off. The bottom panel becomes hot when the power is on (or right after it is turned off) and could cause burns.

Loading the batteries

The batteries included with the unit are to check initial operations; they may not last over a long period. We recommend using alkaline batteries that have a longer life.

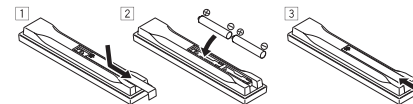

! WARNING

- Do not use or store batteries in direct sunlight or other excessively hot place, such as inside a car or near a heater. This can cause batteries to leak, overheat, explode or catch fire. It can also reduce the life or performance of batteries.

! CAUTION

Incorrect use of batteries may result in such hazards as leakage and bursting. Observe the following precautions:

- Never use new and old batteries together.
- Insert the plus and minus sides of the batteries properly according to the marks in the battery case.

- Batteries with the same shape may have different voltages. Do not use different batteries together.
- When disposing of used batteries, please comply with governmental regulations or environmental public instruction's rules that apply in your country or area.

Operating range of remote control unit

The remote control may not work properly if:

- There are obstacles between the remote control and the receiver's remote sensor.
- Direct sunlight or fluorescent light is shining onto the remote sensor.
- The receiver is located near a device that is emitting infrared rays.
- The receiver is operated simultaneously with another infrared remote control unit.

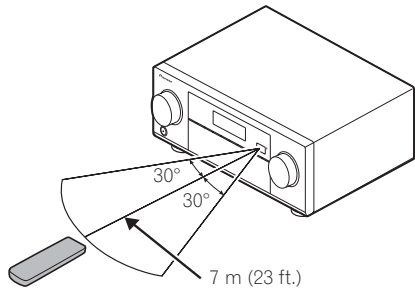

About using AVNavigator (included CD-ROM)

The included AVNavigator CD-ROM contains **Wiring Navi** allowing you to easily make the receiver's connections and initial settings in dialog fashion. High precision initial settings can be completed easily simply by following the

instructions on the screen to make the connections and settings.

There are also other features enabling easy use of various functions, including an Interactive Manual that operates in association with the receiver, updating of various types of software, and MCACC Application that lets you check the MCACC measurement results on 3D graphs.

Installing AVNavigator

1 Load the included AVNavigator CD-ROM into your computer's CD drive.

- The installation screen is displayed. Proceed to step 2.
- If the installation screen does not appear, double-click on the CD-ROM icon then start the installer (AVNV_XXX_XXX.exe).

2 Follow the instructions on the screen to install.

When "Finish" is selected, installation is completed.

3 Remove the included AVNavigator CD-ROM from the computer's CD drive.

Handling the CD-ROM

Operating Environment

- This CD-ROM can be used with Microsoft® Windows® XP/Vista/7.
- A browser is at times used for AVNavigator functions. The supported browser is Microsoft Internet Explorer 6, 7 and 8. With other browsers, some functions may be limited or the display may not appear properly. Also, even with a supported browser, depending on the browser's settings, some functions may be limited and the display may not appear properly.

Precautions For Use

- This CD-ROM is for use with a personal computer. It cannot be used with a DVD player or music CD player. Attempting to play

this CD-ROM with a DVD player or music CD player can damage speakers or cause impaired hearing due to the large volume.

License

- Please agree to the "Terms of Use" indicated below before using this CD-ROM. Do not use if you are unwilling to consent to the terms of its use. Also agree to the "License Agreement" displayed when installing AVNavigator.

Terms of Use

- Copyright to data provided on this CD-ROM belongs to PIONEER CORPORATION. Unauthorized transfer, duplication, broadcast, public transmission, translation, sales, lending or other such matters that go beyond the scope of "personal use" or "citation" as defined by Copyright Law may be subject to punitive actions. Permission to use this CD-ROM is granted under license by PIONEER CORPORATION.

General Disclaimer

- PIONEER CORPORATION does not guarantee the operation of this CD-ROM with respect to personal computers using any of the applicable OS. In addition, PIONEER CORPORATION is not liable for any damages incurred as a result of use of this CD-ROM and is not responsible for any compensation. The names of private corporations, products and other entities described herein are the registered trademarks or trademarks of their respective firms.

Using AVNavigator

1 Click [AVNavigator] on the desktop to launch AVNavigator.

AVNavigator is launched and **Wiring Navi** starts up. The language selection screen appears. Follow the instructions on the screen to make the connections and automatic settings.

Wiring Navi only starts up automatically the first time AVNavigator is launched.

2 Select and use the desired function.

AVNavigator includes the following functions:

- **Wiring Navi** – Guides you through connections and initial settings in dialog fashion. High precision initial settings can be made easily.
- **Interactive Manual** – Automatically displays the pages explaining the functions that have been operated on the receiver. It is also possible to operate the receiver from the Interactive Manual.
- **Glossary** – Displays glossary pages.
- **MCACC Appli** – Displays Advanced MCACC measurement results vividly on the computer. There are special operating instructions for MCACC Application. These instructions are included in the AVNavigator **Interactive Manual**'s menus. Refer to them when using MCACC Application.
- **Software Update** – Allows various types of software to be updated.
- **Settings** – Used to make various AVNavigator settings.
- **Detection** – Used to detect the receiver.



Note

To use the AVNavigator of another model, first uninstall (delete) this receiver's AVNavigator, then install the AVNavigator of the other model.

Deleting the AVNavigator

You can use the following method to uninstall (delete) the AVNavigator from your PC.

● Delete from the Control Panel of the PC.

From the Start menu, click "Program" → "PIONEER CORPORATION" → "AVNavigator(VSX-53 or VSX-52)" → "Uninstall".

Controls and displays

Remote control

This section explains how to operate the remote control for the receiver.

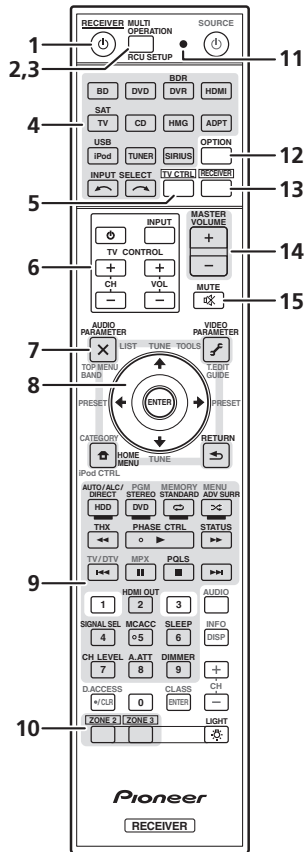

The remote has been conveniently color-coded according to component control using the following system:

- **White** – Receiver control, TV control
- **Blue** – Other controls (See pages 30, 31, 33, 35 and 59.)

1 **RECEIVER**

This switches between standby and on for this receiver.

2 **MULTI OPERATION**

Use this button to perform multi operations (page 58).

3 **RCU SETUP**

Use to input the preset code when making remote control settings and to set the remote control mode (page 56).

4 **Input function buttons**

Press to select control of other components (page 56).

Use **INPUT SELECT** \leftarrow/\rightarrow to select the input function (page 30).

5 **TV CTRL**

Set the preset code of your TV's manufacturer when controlling the TV (page 56).

6 **TV CONTROL buttons**

These buttons are dedicated to control the TV assigned to the **TV CTRL** button.

7 **Receiver setting buttons**

Press **RECEIVER** first to access:

- **AUDIO PARAMETER** – Use to access the Audio options (page 50).
- **VIDEO PARAMETER** – Use to access the Video options (page 52).
- **HOME MENU** – Use to access the Home Menu (pages 26, 28, 47, 62 and 69).
- **RETURN** – Press to confirm and exit the current menu screen.

8 **↑/↓/←/→/ENTER**

Use the arrow buttons when setting up your surround sound system (see page 62) and the Audio or Video options (page 50 or 52).

9 **Receiver Control buttons**

Press **RECEIVER** first to access:

- **AUTO/ALC/DIRECT** – Switches between Auto Surround (page 37), Auto Level Control, Optimum Surround mode and Stream Direct mode (page 38).
- **STEREO** – Press to select stereo playback mode (page 37).
- **STANDARD** – Press for Standard decoding and to switch various modes (Dolby Pro Logic, Neo:6, etc.) (page 37).
- **ADV SURR** – Use to switch between the various surround modes (page 38).
- **THX** – Press to select a Home THX listening mode (page 38).
- **PHASE CTRL** – Press to switch on/off Phase Control (page 39).
On the VSX-53, Full Band Phase Control can also be switched (page 39).
- **STATUS** – Press to check selected receiver settings (page 55).
- **PQLS** – Press to select the PQLS setting (page 48).
- **HDMI OUT** – Switch the HDMI output terminal (page 54).
This function is only provided on the VSX-53. It cannot be used on the VSX-52.
- **SIGNAL SEL** – Use to select an input signal (page 39).
- **MCACC** – Press to switch between MCACC presets (page 39).
- **SLEEP** – Use to put the receiver in sleep mode and select the amount of time before sleep (page 54).
- **CH LEVEL** – Press repeatedly to select a channel, then use \leftarrow/\rightarrow to adjust the level (page 70).

- **A.ATT** – Attenuates (lowers) the level of an analog input signal to prevent distortion (page 54).
- **DIMMER** – Dims or brightens the display (page 54).

10 **MULTI-ZONE select buttons**

Switch to perform operations in **ZONE 2** and **ZONE 3** (page 53).
ZONE 3 function is only provided on the VSX-53.
ZONE 3 button cannot be used on the VSX-52.

11 **Remote control LED**

Lights when a command is sent from the remote control.

12 **OPTION**

The preset codes of desired devices can be registered in the remote control and button operations can be registered using the learning mode.

13 **RECEIVER**

Switches the remote to control the receiver (used to select the white commands).
Switch to perform operations in the main zone. Also use this button to set up surround sound.

14 **MASTER VOLUME +/-**

Use to set the listening volume.

15 **MUTE**

Mutes the sound or restores the sound if it has been muted (adjusting the volume also restores the sound).

16 **LIGHT**

Press to turn on/off the illumination for the buttons.

The way the buttons light can be selected from four modes (page 58).

Display

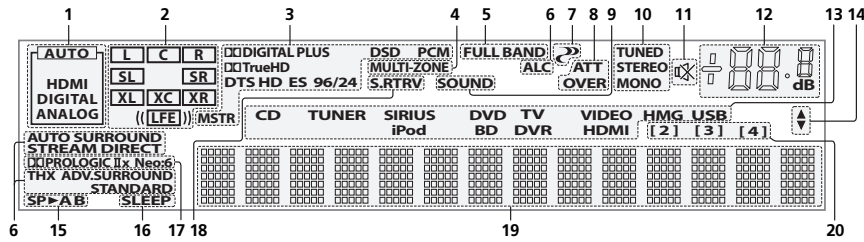

1 Signal indicators

Light to indicate the currently selected input signal. **AUTO** lights when the receiver is set to select the input signal automatically (page 39).

2 Program format indicators

Light to indicate the channels to which digital signals are being input.

- **L/R** – Left front/Right front channel
- **C** – Center channel
- **SL/SR** – Left surround/Right surround channel
- **LFE** – Low frequency effects channel (the **(LFE)** indicators light when an LFE signal is being input)
- **XL/XR** – Two channels other than the ones above
- **XC** – Either one channel other than the ones above, the mono surround channel or matrix encode flag

3 Digital format indicators

Light when a signal encoded in the corresponding format is detected.

- **DIGITAL** – Lights with Dolby Digital decoding.
- **DIGITAL PLUS** – Lights with Dolby Digital Plus decoding.
- **TrueHD** – Lights with Dolby TrueHD decoding.
- **DTS** – Lights with DTS decoding.
- **DTS HD** – Lights with DTS-HD decoding.

- **96/24** – Lights with DTS 96/24 decoding.
- **DSD PCM** – Light during DSD (Direct Stream Digital) to PCM conversion with SACDs.
- **PCM** – Lights during playback of PCM signals.
- **MSTR** – Lights during playback of DTS-HD Master Audio signals.

4 MULTI-ZONE

Lights when the **MULTI-ZONE** feature is active (page 53).

5 FULL BAND

VSX-53 only: Lights when the Full Band Phase Control is switched on (page 39).

6 Listening mode indicators

- **AUTO SURROUND** – Lights when the Auto Surround feature is switched on (page 37).
- **ALC** – Lights when the ALC (Auto level control) mode is selected (page 37).
- **STREAM DIRECT** – Lights when Direct/Pure Direct is selected (page 38).
- **ADV.SURROUND** – Lights when one of the Advanced Surround modes has been selected (page 38).
- **STANDARD** – Lights when one of the Standard Surround modes is switched on (page 37).
- **THX** – Lights when one of the Home THX modes is selected (page 38).

7 PHASE CONTROL

Lights when the Phase Control (page 39) or Full Band Phase Control (page 39) is switched on. Full Band Phase Control is only apply to the VSX-53.

8 Analog signal indicators

Light to indicate reducing the level of an analog signal (page 54).

9 SOUND

Lights when the **DIALOG E** (Dialog Enhancement) or **TONE** (tone controls) features is selected (page 50).

10 Tuner indicators

- **TUNED** – Lights when a broadcast is being received.
- **STEREO** – Lights when a stereo FM broadcast is being received in auto stereo mode.
- **MONO** – Lights when the mono mode is set using **MPX**.

11 MUTE

Lights when the sound is muted.

12 Master volume level

Shows the overall volume level. “---” indicates the minimum level, and “+12dB” indicates the maximum level.

13 Input function indicators

Light to indicate the input function you have selected.

14 Scroll indicators

Light when there are more selectable items when making the various settings.

15 Speaker indicators

Lights to indicate the current speaker system using **SPEAKERS** (page 53).

16 SLEEP

Lights when the receiver is in sleep mode (page 54).

17 Matrix decoding format indicators

- **PRO LOGIC IIx** – This lights to indicate **PRO LOGIC II** / **PRO LOGIC IIx** decoding (page 37).
- **Neo:6** – When one of the Neo:6 modes of the receiver is on, this lights to indicate Neo:6 processing (page 37).

18 S.RTRV

Lights when the Auto Sound Retriever function is active (page 50).

19 Character display

Displays various system information.

20 Remote control mode indicator

Lights to indicate the receiver's remote control mode setting. (Not displayed when set to **1**.) (page 74)

Front panel

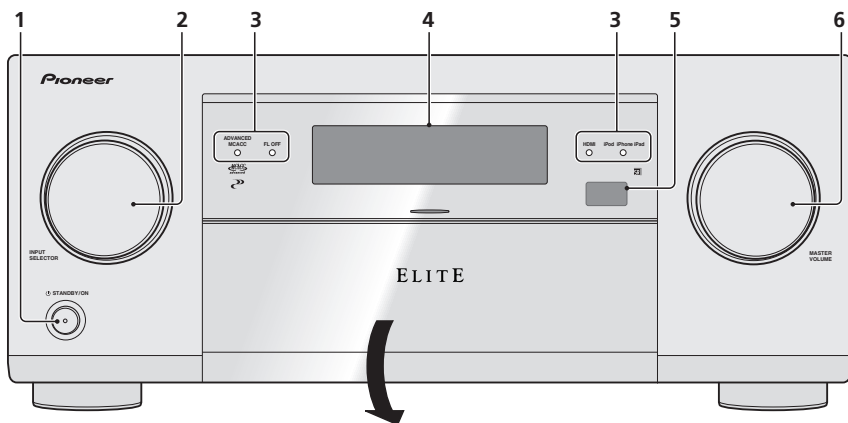

5 Remote sensor

Receives the signals from the remote control (page 7).

6 MASTER VOLUME dial

7 Front panel controls

To access the front panel controls, catch the sides of the door with your fingers and pull forward.

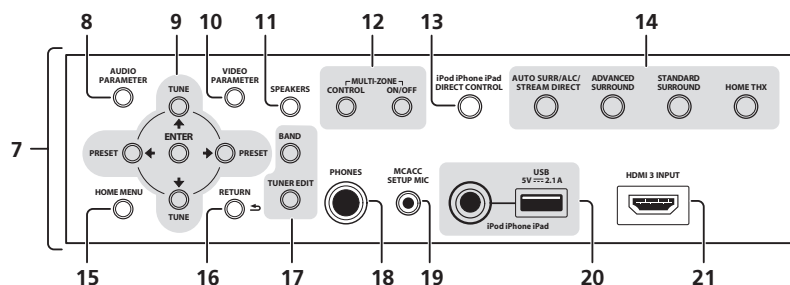
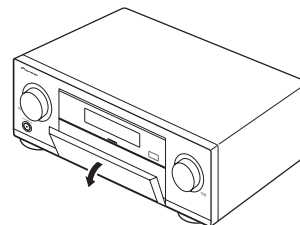

1 STANDBY/ON

This switches between standby and on for this receiver.

2 INPUT SELECTOR dial

Use to select an input function.

3 Indicators

- **ADVANCED MCACC** – Lights when EQ is set to **ON** in the **AUDIO PARAMETER** menu (page 50).

- **FL OFF** – Lights when “off” (nothing displayed) is selected with the display’s dimmer adjustment (page 54).

- **HDMI** – Blinks when connecting an HDMI-equipped component; lights when the component is connected (page 17).

- **iPod iPhone iPad** – Lights to indicate iPod/iPhone/iPad is connected (page 23).

4 Character display

See *Display* on page 9.

8 AUDIO PARAMETER

Use to access the Audio options (page 50).

9 (TUNE/PRESET) /ENTER

Use the arrow buttons when setting up your **Home Menu**. Use **TUNE** to find radio frequencies and use **PRESET** to find preset stations (page 33).

10 VIDEO PARAMETER

Use to access the Video options (page 52).

11 SPEAKERS

Use to change the speaker terminal (page 53).

12 MULTI-ZONE controls

If you’ve made MULTI-ZONE connections (page 21) use these controls to control the sub zone from the main zone (page 53).

13 iPod iPhone iPad DIRECT CONTROL

Change the receiver’s input to the iPod and enable iPod operations on the iPod (page 31).

14 Listening mode buttons

- **AUTO SURR/ALC/STREAM DIRECT** – Switches between Auto Surround (page 37), Auto Level Control, Optimum Surround mode and Stream Direct mode (page 38).

- **STANDARD SURROUND** – Press for Standard decoding and to switch various modes (Pro Logic, Neo:6, Stereo etc.) (page 37).
- **ADVANCED SURROUND** – Use to switch between the various surround modes (page 38).
- **HOME THX** – Press to select a Home THX listening mode (page 38).

15 HOME MENU

Use to access the Home Menu (page 26, 28, 47, 62 and 69).

16 RETURN

Press to confirm and exit the current menu screen.

17 TUNER controls

- **BAND** – Switches between AM and FM radio bands (page 33).
- **TUNER EDIT** – Use with **TUNE** , **PRESET** and **ENTER** to memorize and name stations for recall (page 33).

18 PHONES jack

Use to connect headphones. When the headphones are connected, there is no sound output from the speakers.

19 MCACC SETUP MIC jack

Use to connect the supplied microphone (page 26).

20 iPod iPhone iPad USB terminals

Use to connect your Apple iPod/iPhone/iPad as an audio and video source (page 23), or connect a USB device for audio and photo playback (page 23).

21 HDMI input connector

Use for connection to a compatible HDMI device (Video camera, etc.) (page 23).

Connecting your equipment

Connecting your equipment

This receiver provides you with many connection possibilities, but it doesn't have to be difficult. This chapter explains the kinds of components you can connect to make up your home theater system.

CAUTION

Before making or changing the connections, switch off the power and disconnect the power cord from the power outlet. Plugging in should be the final step.

Important

Illustration shows the VSX-53, however connections for the VSX-52 are the same except where noted.

Rear panel

VSX-53

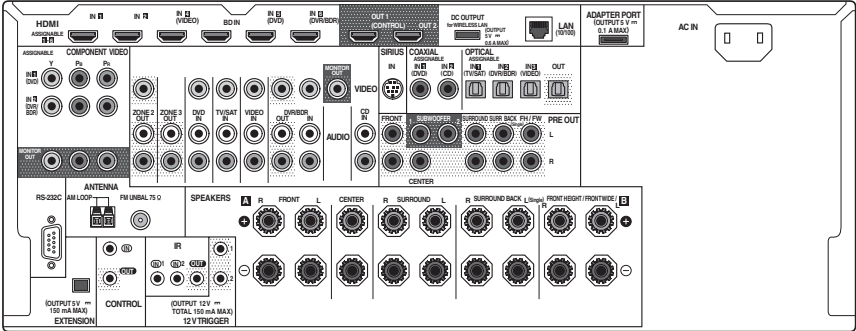

VSX-52

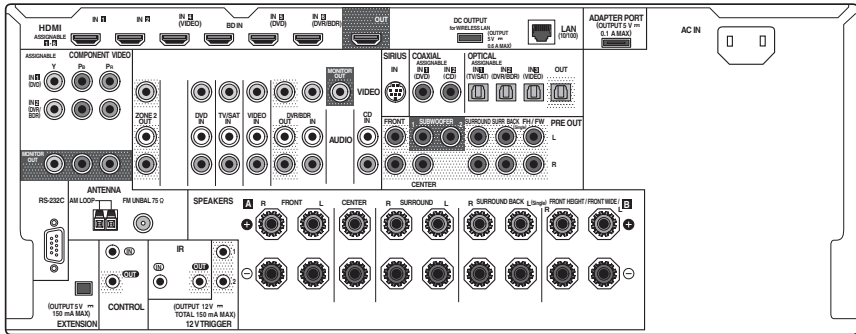

Note

- The input functions below are assigned by default to the receiver's different input terminals. Refer to *The Input Setup menu* on page 28 to change the assignments if other connections are used.

Input function	Input Terminals		
	HDMI	Digital	Component
BD	(BD)		
DVD	IN 5	COAX-1	IN 1
TV/SAT		OPT-1	
DVR/BDR	IN 6	OPT-2	IN 2
VIDEO	IN 4	OPT-3	
HDMI 1	IN 1		
HDMI 2	IN 2		
HDMI 3 (front panel)	IN 3		
CD		COAX-2	

- The CU-RF100 omni-directional remote control (separately sold) can be connected to the **RS-232C** and **EXTENSION** terminals. Using the CU-RF100 lets you display the receiver's display information on the remote control display in your hands and operate it without worrying about obstacles or the direction in which the remote control is pointing.

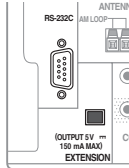

Determining the speakers' application

This unit permits you to build various surround systems, in accordance with the number of speakers you have.

- Be sure to connect speakers to the front left and right channels (**L** and **R**).
- It is also possible to only connect one of the surround back speakers (**SB**) or neither.
- If you have two subwoofers, the second subwoofer can be connected to the **SUBWOOFER 2** terminal. Connecting two subwoofers increases the bass sound to achieve more powerful sound reproduction. In this case, the same sound is output from the two subwoofers.

Choose one from Plans [A] to [E] below.

Important

- The **Speaker System** setting must be made if you use any of the connections shown below other than [A] (see *Speaker system setting* on page 69).
- Sound does not come through simultaneously from the front height, front wide, speaker B and surround back speakers. Output speakers are different depending on the input signal or listening mode.

[A] 7.2 channel surround system (Front height)

*Default setting

- **Speaker System** setting: Normal(SB/FH)

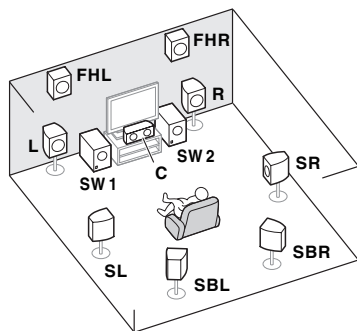

A 7.2 ch surround system connects the left and right front speakers (**L/R**), the center speaker (**C**), the left and right front height speakers (**FHL/FHR**), the left and right surround speakers (**SL/SR**), the left and right surround back speakers (**SBL/SBR**), and the subwoofers (**SW 1/SW 2**).

It is not possible to produce sound simultaneously from the front height or front wide speakers and the surround back speakers. This surround system produces a more true-to-life sound from above.

[B] 7.2 channel surround system (Front wide)

- **Speaker System** setting: Normal(SB/FW)

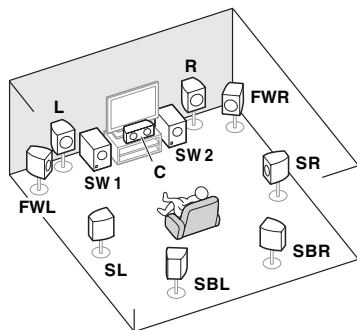

This plan replaces the left and right front height speakers shown in [A] with the left and right front wide speakers (**FWL/FWR**).

It is not possible to produce sound simultaneously from the front height or front wide speakers and the surround back speakers.

This surround system produces a true-to-life sound over a wider area.

[C] 7.2 channel surround system & Speaker B connection

- **Speaker System** setting: Speaker B

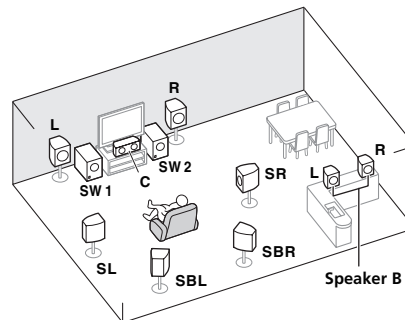

With these connections you can simultaneously enjoy 5.2-channel surround sound in the main zone with stereo playback of the same sound on the B speakers. The same connections also allow for 7.2-channel surround sound in the main zone when not using the B speakers.

[D] 5.2 channel surround system & Front Bi-amping connection (High quality surround)

- **Speaker System** setting: Front Bi-Amp
Bi-amping connection of the front speakers for high sound quality with 5.2-channel surround sound.

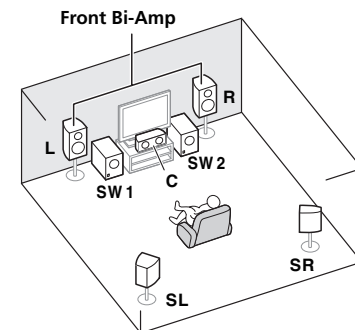

[E] 5.2 channel surround system & ZONE 2 connection (Multi Zone)

- **Speaker System** setting: ZONE 2
With these connections you can simultaneously enjoy 5.2-channel surround sound in the main zone with stereo playback on another component in ZONE 2. (The selection of input devices is limited.)

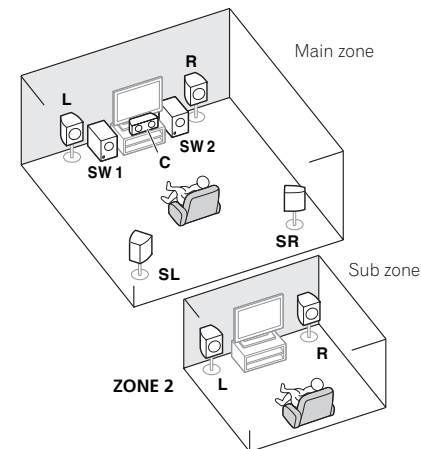

Other speaker connections

- Your favorite speaker connections can be selected even if you have fewer than 5.2 speakers (except front left/right speakers).
- When not connecting a subwoofer, connect speakers with low frequency reproduction capabilities to the front channel. (The subwoofer's low frequency component is played from the front speakers, so the speakers could be damaged.)
- After connecting, be sure to conduct the **Full Auto MCACC** (speaker environment setting) procedure. See *Automatically conducting optimum sound tuning (Full Auto MCACC)* on page 26 .

Placing the speakers

Refer to the chart below for placement of the speakers you intend to connect.

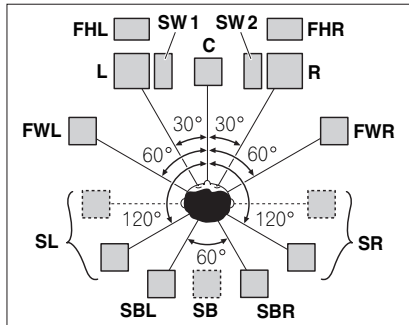

- Place the surround speakers at 120° from the center. If you, (1) use the surround back speaker, and, (2) don't use the front height speakers / front wide speakers, we recommend placing the surround speaker right beside you.
- If you intend to connect only one surround back speaker, place it directly behind you.

- Place the left and right front height speakers at least one meter (3.3 ft.) directly above the left and right front speakers.

THX speaker system setup

If you are using a THX certified subwoofer, use the **THX INPUT** jack on the subwoofer (if your subwoofer has one) or switch the filter position to **THX** on your subwoofer. See also *THX Audio Setting* on page 71 to make the settings that will give you the best sound experience when using the Home THX modes (page 38).

Some tips for improving sound quality

Where you put your speakers in the room has a big effect on the quality of the sound. The following guidelines should help you to get the best sound from your system.

- The subwoofer can be placed on the floor. Ideally, the other speakers should be at about ear-level when you're listening to them. Putting the speakers on the floor (except the subwoofer), or mounting them very high on a wall is not recommended.
- For the best stereo effect, place the front speakers 2 m to 3 m (6 ft. to 9 ft.) apart, at equal distance from the TV.
- If you're going to place speakers around your CRT TV, use shielded speakers or place the speakers at a sufficient distance from your CRT TV.
- If you're using a center speaker, place the front speakers at a wider angle. If not, place them at a narrower angle.
- Place the center speaker above or below the TV so that the sound of the center channel is localized at the TV screen. Also, make sure the center speaker does not cross the line formed by the leading edge of the front left and right speakers.

- It is best to angle the speakers towards the listening position. The angle depends on the size of the room. Use less of an angle for bigger rooms.
- Surround and surround back speakers should be positioned 60 cm to 90 cm (2 ft. to 3 ft.) higher than your ears and tilted slightly downward. Make sure the speakers don't face each other. For DVD-Audio, the speakers should be more directly behind the listener than for home theater playback.
- Try not to place the surround speakers farther away from the listening position than the front and center speakers. Doing so can weaken the surround sound effect.

Connecting the speakers

Each speaker connection on the receiver comprises a positive (+) and negative (-) terminal. Make sure to match these up with the terminals on the speakers themselves.

⚠ CAUTION

- These speaker terminals carry **HAZARDOUS LIVE** voltage. To prevent the risk of electric shock when connecting or disconnecting the speaker cables, disconnect the power cord before touching any uninsulated parts.
- Make sure that all the bare speaker wire is twisted together and inserted fully into the speaker terminal. If any of the bare speaker wire touches the back panel it may cause the power to cut off as a safety measure.

Bare wire connections

⚠ CAUTION

Make sure that all speakers are securely installed. This not only improves sound quality, but also reduces the risk of damage or injury resulting from speakers being knocked over or falling in the event of external shocks such as earthquakes.

- Twist exposed wire strands together.
- Loosen terminal and insert exposed wire.
- Tighten terminal.

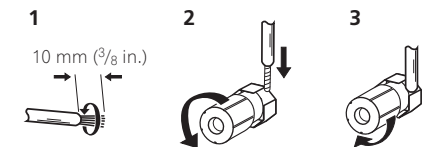

**Note**

- Please refer to the manual that came with your speakers for details on how to connect the other end of the speaker cables to your speakers.
- Use an RCA cable to connect the subwoofer. It is not possible to connect using speaker cables.
- If you have two subwoofers, the second subwoofer can be connected to the **SUBWOOFER 2** terminal. Connecting two subwoofers increases the bass sound to achieve more powerful sound reproduction. In this case, the same sound is output from the two subwoofers.

Banana plug connections

If you want to use speaker cables terminated with banana plugs, screw the speaker terminal fully shut, then plug the banana plug into the end of the speaker terminal.

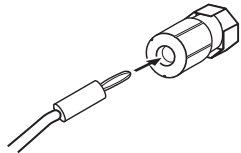
**Installing your speaker system**

At the very least, front left and right speakers only are necessary. Note that your main surround speakers should always be connected as a pair, but you can connect just one surround back speaker if you like (it must be connected to the left surround back terminal).

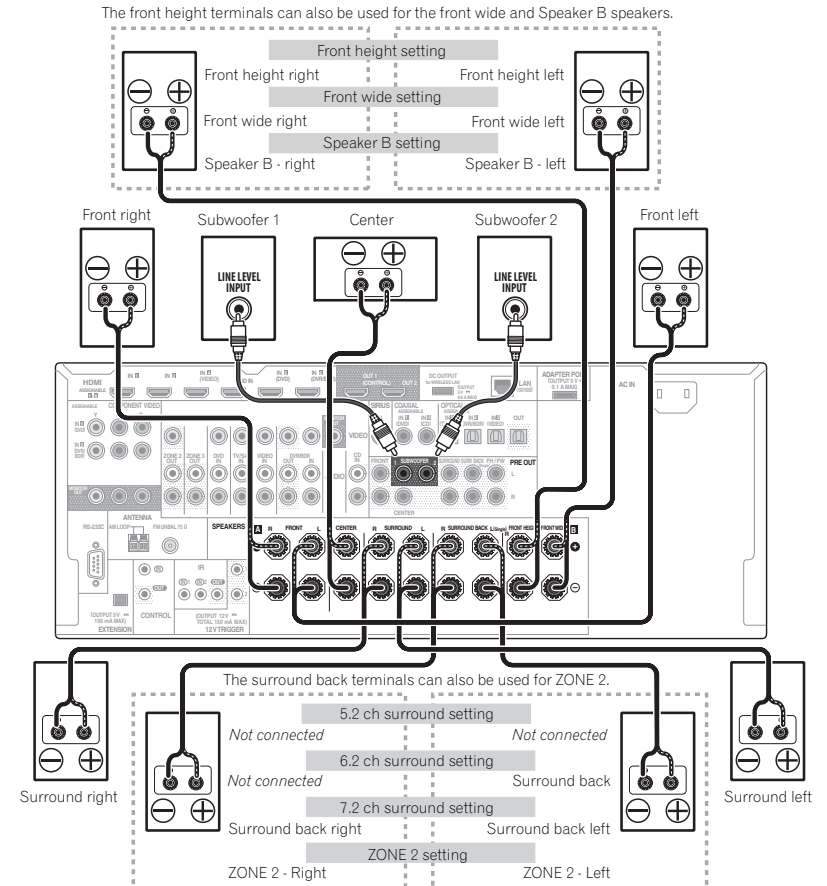
Standard surround connection

Bi-amping your speakers

Bi-amping is when you connect the high frequency driver and low frequency driver of your speakers to different amplifiers for better crossover performance. Your speakers must be bi-ampable to do this (having separate terminals for high and low) and the sound improvement will depend on the kind of speakers you're using.

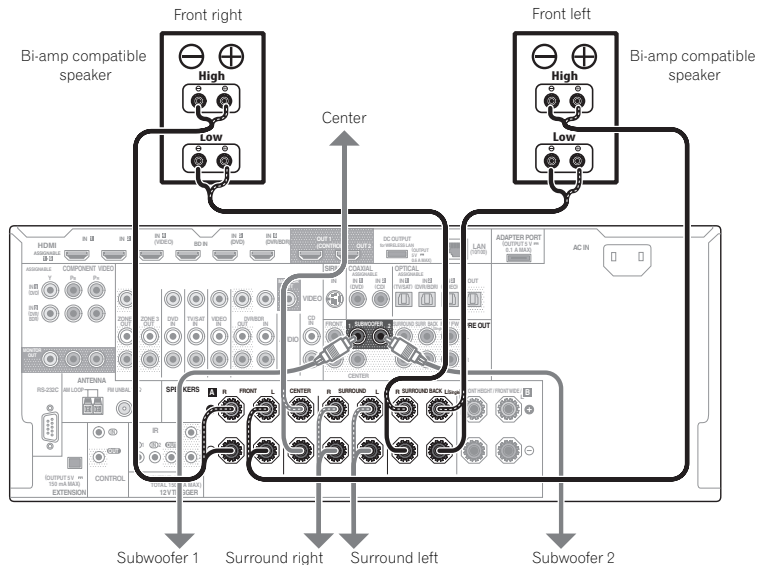

CAUTION

- Most speakers with both **High** and **Low** terminals have two metal plates that connect the **High** to the **Low** terminals. These must be removed when you are bi-amping the speakers or you could severely damage the amplifier. See your speaker manual for more information.
- If your speakers have a removable crossover network, make sure you do not remove it for bi-amping. Doing so may damage your speakers.

Bi-wiring your speakers

Your speakers can also be bi-wired if they support bi-amping.

- With these connections, the **Speaker System** setting makes no difference.

CAUTION

- Don't connect different speakers from the same terminal in this way.
- When bi-wiring as well, heed the cautions for bi-amping shown above.

- **To bi-wire a speaker, connect two speaker cords to the speaker terminal on the receiver.**

Using a banana plug for the second connection is recommended.

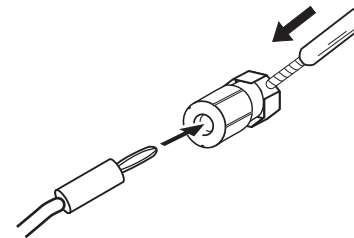

Selecting the Speaker system

The front height terminals can be used for front wide and Speaker B connections, in addition to for the front height speakers. Also, the surround back terminals can be used for bi-amping and ZONE 2 connections, in addition to for the surround back speakers. Make this setting according to the application.

Front height setup

**Default setting*

- 1 **Connect a pair of speakers to the front height speaker terminals.**

See *Standard surround connection* on page 14 .

- 2 **If necessary, select 'Normal(SB/FH)' from the Speaker System menu.**

See *Speaker system setting* on page 69 to do this.

Front wide setup

- 1 **Connect a pair of speakers to the front height speaker terminals.**

See *Standard surround connection* on page 14 .

- 2 **Select 'Normal(SB/FW)' from the Speaker System menu.**

See *Speaker system setting* on page 69 to do this.

Speaker B setup

You can listen to stereo playback in another room.

- 1 **Connect a pair of speakers to the front height speaker terminals.**

See *Standard surround connection* on page 14 .

- 2 **Select 'Speaker B' from the Speaker System menu.**

See *Speaker system setting* on page 69 to do this.

Bi-Amping setup

Bi-amping connection of the front speakers for high sound quality with 5.2-channel surround sound.

1 Connect bi-amp compatible speakers to the front and surround back speaker terminals.

See *Bi-amping your speakers* on page 15 .

2 Select 'Front Bi-Amp' from the Speaker System menu.

See *Speaker system setting* on page 69 to do this.

ZONE 2 setup

With these connections you can simultaneously enjoy 5.2-channel surround sound in the main zone with stereo playback on another component in ZONE 2.





1 Connect a pair of speakers to the surround back speaker terminals.

See *Standard surround connection* on page 14 .

2 Select 'ZONE 2' from the Speaker System menu.

See *Speaker system setting* on page 69 to do this.

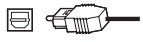
About the audio connection

	Types of cables and terminals	Transferable audio signals
↑ Sound signal priority	HDMI 	HD audio
	Digital (Coaxial) 	Conventional digital audio
	Digital (Optical) 	
	RCA (Analog) (White/Red) 	Conventional analog audio

- With an HDMI cable, video and audio signals can be transferred in high quality over a single cable.

About the video converter

The video converter ensures that all video sources are output through all of the **MONITOR VIDEO OUT** jacks. The only exception is HDMI: since this resolution cannot be downsampled, you must connect your monitor/TV to the receiver's HDMI output when connecting this video source.

If several video components are assigned to the same input function (see *The Input Setup menu* on page 28), the converter gives priority to HDMI, component, then composite (in that order).

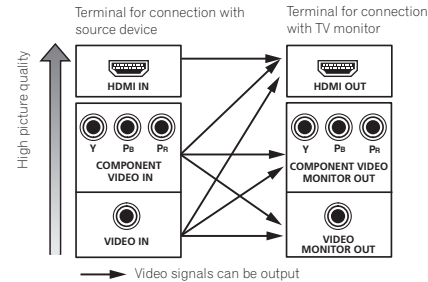

Note

- If the video signal does not appear on your TV, try adjusting the resolution settings on your component or display. Note that some components (such as video game units) have resolutions that may not be converted. In this case, try switching Digital Video Conversion (in *Setting the Video options* on page 52) **OFF**.
- The signal input resolutions that can be converted from the component video input for the HDMI output are 480i/576i, 480p/576p, 720p and 1080i. 1080p signals cannot be converted.
- Only signals with an input resolution of 480i/576i can be converted from the component video input for the composite **MONITOR OUT** terminals.
- For optimal video performance, THX recommends switching Digital Video Conversion (in *Setting the Video options* on page 52) **OFF**.

This item incorporates copy protection technology that is protected by U.S. patents and other intellectual property rights of Rovi Corporation. Reverse engineering and disassembly are prohibited.

About HDMI

The HDMI connection transfers uncompressed digital video, as well as almost every kind of digital audio.

This receiver incorporates High-Definition Multimedia Interface (HDMI®) technology. This receiver supports the functions described below through HDMI connections.

- Digital transfer of uncompressed video (contents protected by HDCP (1080p/24, 1080p/60, etc.))
- 3D signal transfer
- Deep Color signal transfer
- x.v.Color signal transfer
- ARC (Audio Return Channel)
- Input of multi-channel linear PCM digital audio signals (192 kHz or less) for up to 8 channels
- Input of the following digital audio formats:
 - Dolby Digital, Dolby Digital Plus, DTS, High bitrate audio (Dolby TrueHD, DTS-HD Master Audio, DTS-HD High Resolution Audio), DVD-Audio, CD, SACD (DSD signal), Video CD, Super VCD
- Synchronized operation with components using the **Control** with HDMI function (see *Control with HDMI function* on page 47)

Note

- An HDMI connection can only be made with DVI-equipped components compatible with both DVI and High Bandwidth Digital Content Protection (HDCP). If you choose to connect to a DVI connector, you will need a separate adaptor (DVI→HDMI) to do so. A DVI connection, however, does not support audio signals. Consult your local audio dealer for more information.

- If you connect a component that is not compatible with HDCP, an **HDCP ERROR** message is displayed on the front panel display. Some components that are compatible with HDCP still cause this message to be displayed, but so long as there is no problem with displaying video this is not a malfunction.
- Depending on the component you have connected, using a DVI connection may result in unreliable signal transfers.
- This receiver supports SACD, Dolby Digital Plus, Dolby TrueHD and DTS-HD Master Audio. To take advantage of these formats, however, make sure that the component connected to this receiver also supports the corresponding format.
- Use a High Speed HDMI® cable. If an HDMI cable other than a High Speed HDMI® cable is used, it may not work properly.
- When an HDMI cable with a built-in equalizer is connected, it may not operate properly.
- Signal transfer is only possible when connected to a compatible component.
- HDMI format digital audio transmissions require a longer time to be recognized. Due to this, interruption in the audio may occur when switching between audio formats or beginning playback.
- Turning on/off the device connected to this unit's **HDMI OUT** terminal during playback, or disconnecting/connecting the HDMI cable during playback, may cause noise or interrupted audio.

HDMI, the HDMI logo and High-Definition Multimedia Interface are trademarks or registered trademarks of HDMI Licensing, LLC in the United States and other countries.

"x.v.Color" and **x.v.Color** are trademarks of Sony Corporation.

Connecting your TV and playback components

Connecting using HDMI

If you have an HDMI or DVI (with HDCP) equipped component (Blu-ray Disc player (BD), etc.), you can connect it to this receiver using a commercially available HDMI cable.

If the TV and playback components support the **Control** with HDMI feature, the convenient **Control** with HDMI functions can be used (see *Control with HDMI function* on page 47).

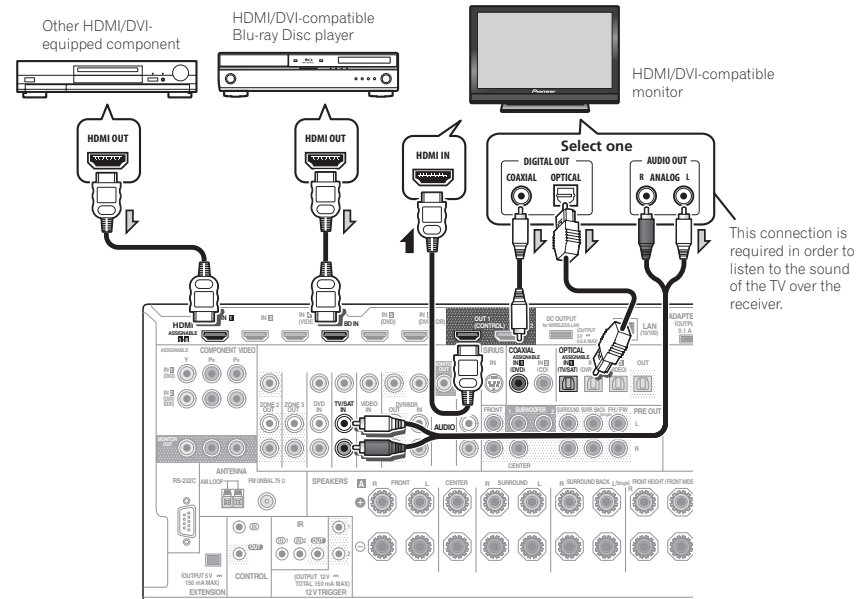

- *VSX-53 only:* When connecting to an HDMI/DVI-compatible monitor using the **HDMI OUT 2** terminal, switch the HDMI output setting to **HDMI OUT 2** or **HDMI OUT ALL**. See *Switching the HDMI output* on page 54.
- For input components, connections other than HDMI connections are also possible (see *Connecting your DVD player with no HDMI output* on page 18).
- If you want to listen to the sound of the TV over the receiver, connect the receiver and TV with audio cables.
- When the TV and receiver are connected by HDMI connections, if the TV supports the HDMI ARC (Audio Return Channel) function, the sound of the TV is input to the receiver via the **HDMI OUT** terminal, so there is no need to connect an audio cable. In this case, set **TV Audio** at **HDMI Setup** to **via HDMI** (see *HDMI Setup* on page 47).

Connecting your DVD player with no HDMI output

This diagram shows connections of a TV (with HDMI input) and DVD player (or other playback component with no HDMI output) to the receiver.

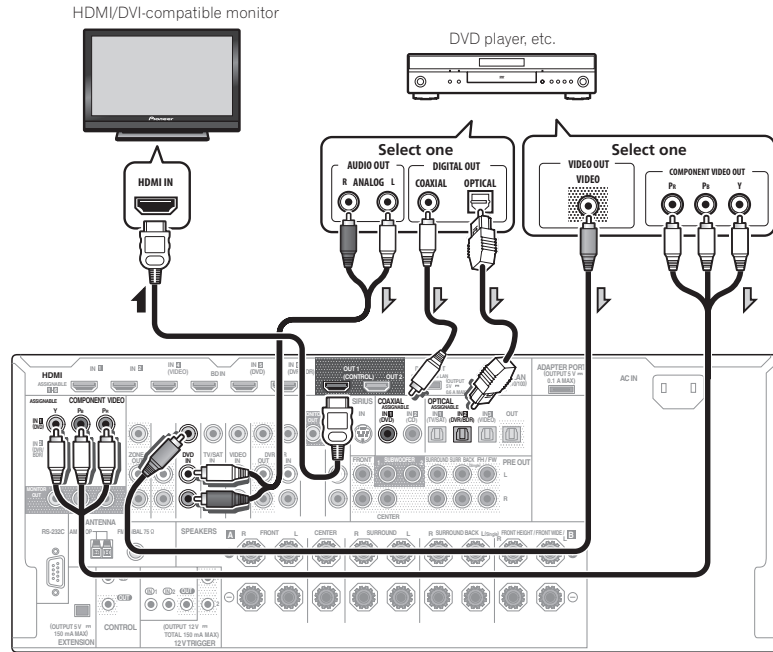

- If you want to listen to the sound of the TV over the receiver, connect the receiver and TV with audio cables (page 17).
- When the TV and receiver are connected by HDMI connections, if the TV supports the HDMI ARC (Audio Return Channel) function, the sound of the TV is input to the receiver via the **HDMI OUT** terminal, so there is no need to connect an audio cable. In this case, set **TV Audio** at **HDMI Setup** to **via HDMI** (see *HDMI Setup* on page 47).
- If you use an optical digital audio cable, you'll need to tell the receiver which digital input you connected the player to (see *The Input Setup menu* on page 28).

Connecting your TV with no HDMI input

This diagram shows connections of a TV (with no HDMI input) and DVD player (or other playback component) to the receiver.

- With these connections, the picture is not output to the TV even if the DVD player is connected with an HDMI cable. Connect the receiver and TV using the same type of video cable as used to connect the receiver and player.

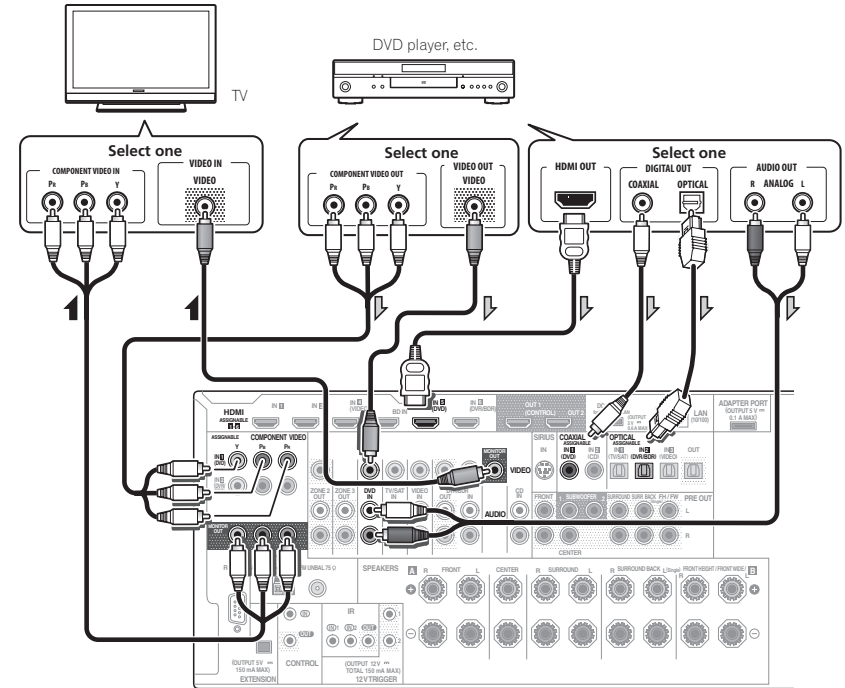

- Connect using an HDMI cable to listen to HD audio on the receiver. Do not use an HDMI cable to input video signals. Depending on the video component, it may not be possible to output signals connected by HDMI and other methods simultaneously, and it may be necessary to make output settings. Please refer to the operating instructions supplied with your component for more information.
- If you want to listen to the sound of the TV over the receiver, connect the receiver and TV with audio cables (page 17).
- If you use an optical digital audio cable, you'll need to tell the receiver which digital input you connected the player to (see *The Input Setup menu* on page 28).

Connecting an HDD/DVD recorder, BD recorder and other video sources

This receiver has two sets of audio/video inputs and outputs suitable for connecting analog or digital video devices, including HDD/DVD recorders and BD recorders. When you set up the receiver you'll need to tell the receiver which input you connected the recorder to (see also *The Input Setup menu* on page 28).

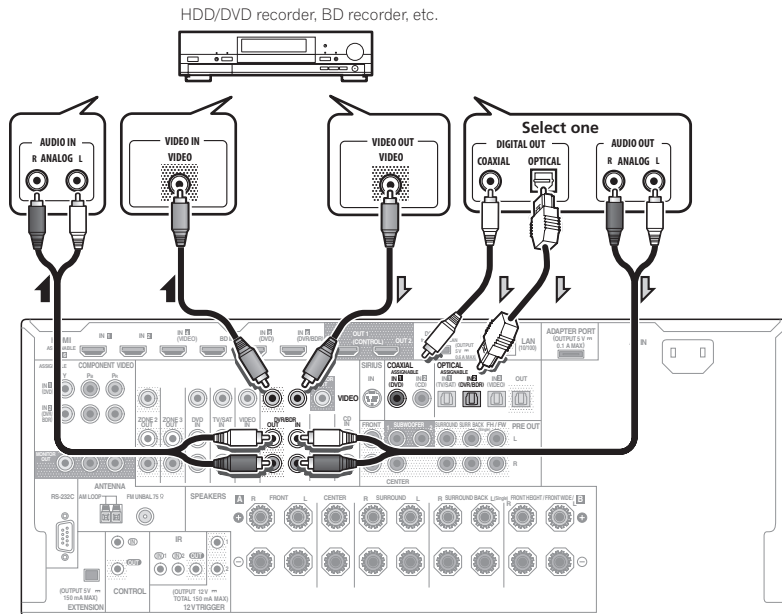

- In order to record, you must connect the analog audio cables (the digital connection is for playback only) (page 54).
- If your HDD/DVD recorder, BD recorder, etc., is equipped with an HDMI output terminal, we recommend connecting it to the receiver's **HDMI DVR/BDR IN** terminal. When doing so, also connect the receiver and TV by HDMI (see *Connecting using HDMI* on page 17).

Connecting a satellite/cable receiver or other set-top box

Satellite and cable receivers, and terrestrial digital TV tuners are all examples of so-called 'set-top boxes'.

When you set up the receiver you'll need to tell the receiver which input you connected the set-top box to (see *The Input Setup menu* on page 28).

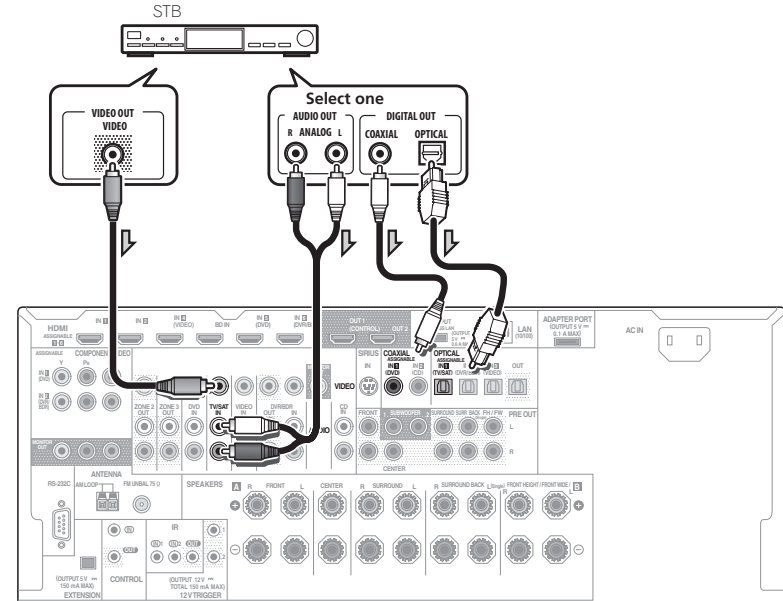

- If your set-top box is equipped with an HDMI output terminal, we recommend connecting it to the receiver's **HDMI IN 1** or **IN 2** terminal. When doing so, also connect the receiver and TV by HDMI (see *Connecting using HDMI* on page 17).

Connecting other audio components

This receiver has both digital and analog inputs, allowing you to connect audio components for playback.

When you set up the receiver you'll need to tell the receiver which input you connected the component to (see also *The Input Setup menu* on page 28).

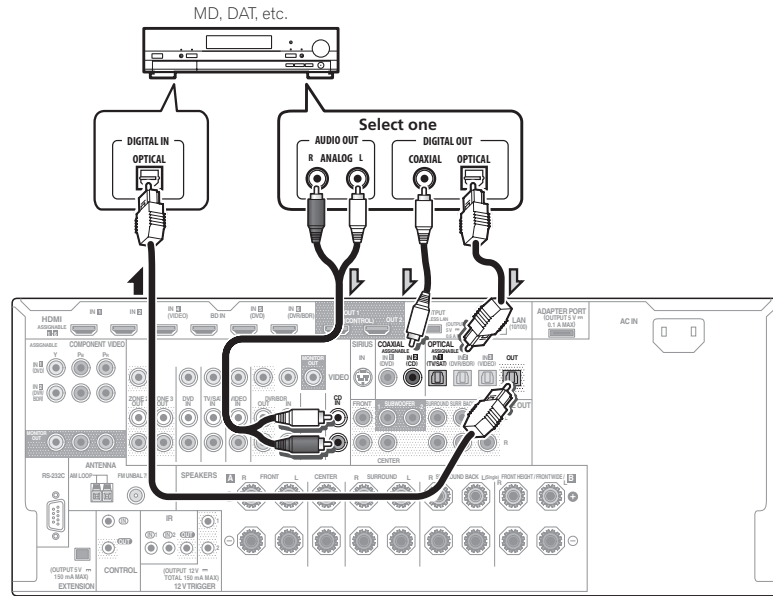

- If your turntable has line-level outputs (i.e., it has a built-in phono pre-amp), connect it to the **CD** inputs instead.
- You can't hear HDMI audio through this receiver's digital out jack.

Connecting additional amplifiers

This receiver has more than enough power for any home use, but it's possible to add additional amplifiers to every channel of your system using the pre-outs. Make the connections shown below to add amplifiers to power your speakers.

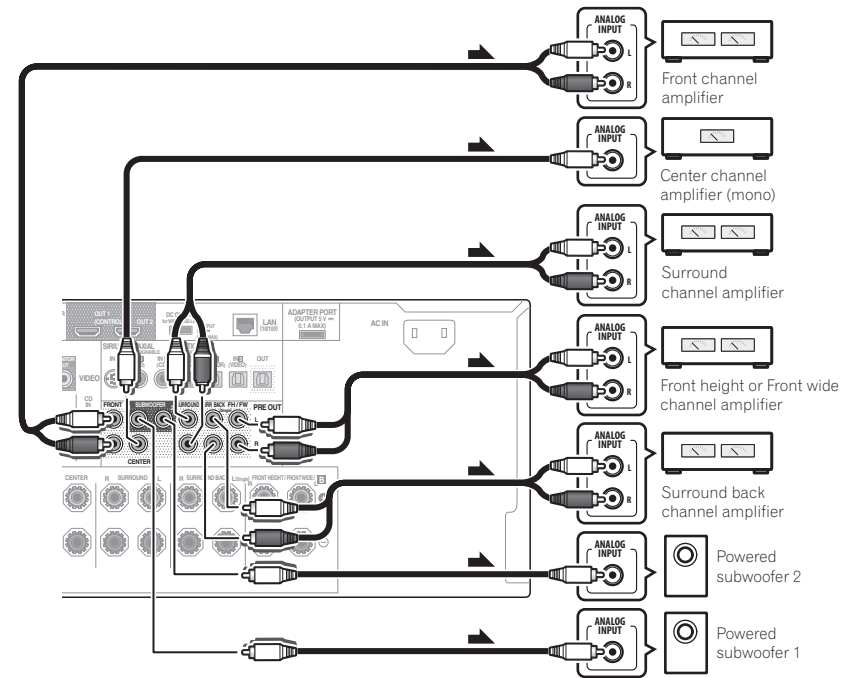

- If you're not using a subwoofer, change the front speaker setting (see *Speaker Setting* on page 66) to **LARGE**.
- You can use the additional amplifier on the surround back channel pre-outs for a single speaker as well. In this case plug the amplifier into the left (**SURROUND BACK L (Single)**) terminal only.
- The sound from the surround back terminals will depend on how you have configured the *Speaker system setting* on page 69.
- If you have two subwoofers, the second subwoofer can be connected to the **SUBWOOFER 2** terminal. Connecting two subwoofers increases the bass sound to achieve more powerful sound reproduction. In this case, the same sound is output from the two subwoofers.
- To hear sound only from the pre-outs, switch the speaker system to **OFF**, or simply disconnect any speakers that are connected directly to the receiver.

Connecting AM/FM antennas

Connect the AM loop antenna and the FM wire antenna as shown below. To improve reception and sound quality, connect external antennas (see *Connecting external antennas* on page 21).

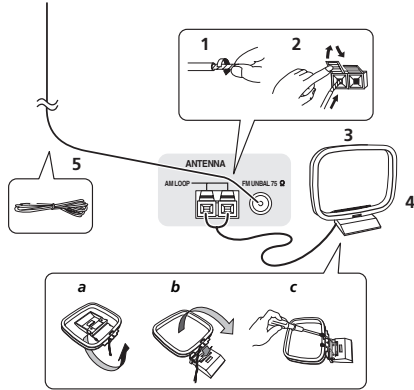

- 1 Pull off the protective shields of both AM antenna wires.**
- 2 Push open the tabs, then insert one wire fully into each terminal, then release the tabs to secure the AM antenna wires.**
- 3 Fix the AM loop antenna to the attached stand.**
To fix the stand to the antenna, bend in the direction indicated by the arrow (fig. a) then clip the loop onto the stand (fig. b).
 - If you plan to mount the AM antenna to a wall or other surface, secure the stand with screws (fig. c) before clipping the loop to the stand. Make sure the reception is clear.
- 4 Place the AM antenna on a flat surface and in a direction giving the best reception.**

5 Connect the FM wire antenna into the FM antenna socket.

For best results, extend the FM antenna fully and fix to a wall or door frame. Don't drape loosely or leave coiled up.

Connecting external antennas

To improve FM reception, connect an external FM antenna to **FM UNBAL 75 Ω**.

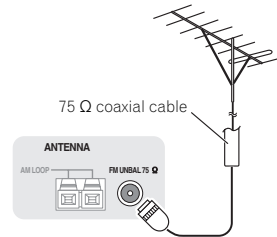

To improve AM reception, connect a 5 m to 6 m (16 ft. to 20 ft.) length of vinyl-coated wire to the **AM LOOP** terminals without disconnecting the supplied AM loop antenna. For the best possible reception, suspend horizontally outdoors.

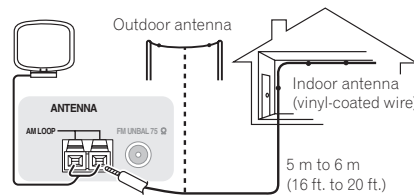

MULTI-ZONE setup

This receiver can power up to three (VSX-53)/two (VSX-52) independent systems in separate rooms after you have made the proper MULTI-ZONE connections.

Different sources can be playing in three (VSX-53)/two (VSX-52) zones at the same time or, depending on your needs, the same source can also be used. The main and sub zone have independent power (the main zone power can be off while one (or both) of the sub zones is on) and the sub zones can be controlled by the remote or front panel controls.

Important

The explanations for ZONE 3 below only apply to the VSX-53.

Making MULTI-ZONE connections

It is possible to make these connections if you have a separate TV and speakers for your primary (ZONE 2) sub zone, and a separate TV and a separate amplifier (and speakers) for your secondary (ZONE 3) sub zone. You will also need a separate amplifier if you are not using the *MULTI-ZONE setup using speaker terminals* (ZONE 2) on page 21 for your primary sub zone. There are two primary sub zone setups possible with this system. Choose whichever works best for you.

MULTI-ZONE listening options

The following table shows the signals that can be output to ZONE 2 and ZONE 3:

Sub Zone	Input functions available
ZONE 2	DVD, TV/SAT, DVR/BDR, VIDEO, HOME MEDIA GALLERY, iPod/USB, CD, TUNER, ADAPTER PORT, SIRIUS (Outputs analog audio, composite video.)

Sub Zone	Input functions available
ZONE 3	DVD, TV/SAT, DVR/BDR, VIDEO, CD, TUNER, ADAPTER PORT (Outputs analog audio)

It is not possible to down-convert the audio and video input signals from the **HDMI** input terminals, digital input terminals (**OPTICAL** and **COAXIAL**) and the **COMPONENT VIDEO** input terminals and output them to ZONE 2.

Basic MULTI-ZONE setup (ZONE 2)

- 1 Connect a separate amplifier to the AUDIO ZONE 2 OUT jacks on this receiver.**
You should have a pair of speakers attached to the sub zone amplifier as shown in the following illustration.
- 2 Connect a TV monitor to the VIDEO ZONE 2 OUT jack on this receiver.**

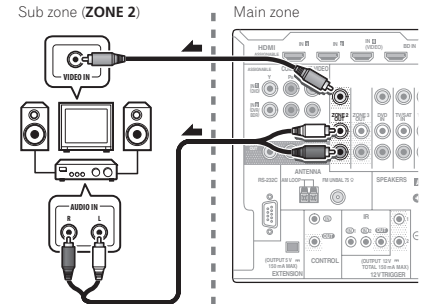

MULTI-ZONE setup using speaker terminals (ZONE 2)

You must select **ZONE 2** in *Speaker system setting* on page 69 to use this setup.

- 1 Connect a pair of speakers to the surround back speaker terminals.**

2 Connect a TV monitor to the VIDEO ZONE 2 OUT jack on this receiver.

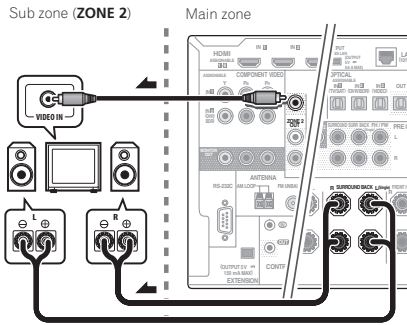

Secondary MULTI-ZONE setup (ZONE 3)

● Connect a separate amplifier to the AUDIO ZONE 3 OUT jacks on this receiver.

You should have a pair of speakers attached to the sub zone amplifier as shown in the following illustration.

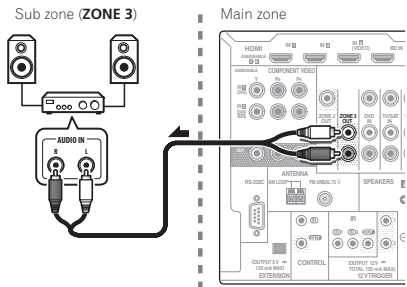

Connecting a SiriusConnect Tuner

To receive SIRIUS Satellite Radio broadcasts, you will need to activate your SiriusConnect™ tuner.

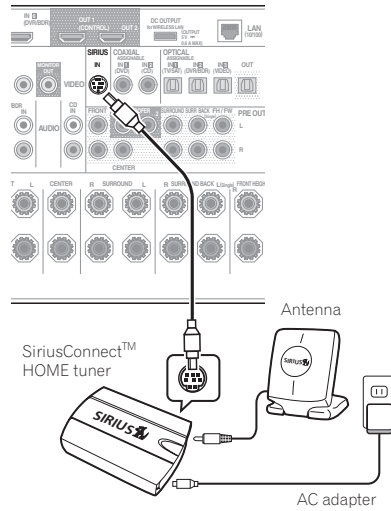

You will also need to connect the antenna and AC adapter to the SiriusConnect™ tuner.

- For instructions on playing the SIRIUS Radio, see *Listening to Satellite Radio* on page 33.

Connecting to the network through LAN interface

By connecting this receiver to the network via the LAN terminal, you can listen to Internet radio stations. To listen to Internet radio stations, you must sign a contract with an ISP (Internet Service Provider) beforehand. When connected in this way, you can play audio files stored on the components on the network, including your computer, using HOME MEDIA GALLERY inputs.

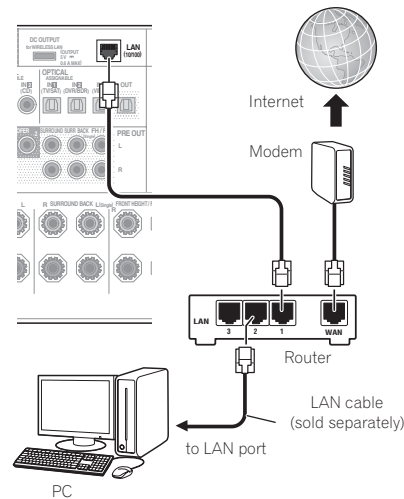

Connect the LAN terminal on this receiver to the LAN terminal on your router (with or without the built-in DHCP server function) with a straight LAN cable (CAT 5 or higher). Turn on the DHCP server function of your router. In case your router does not have the built-in DHCP server function, it is necessary to set up the network manually. For details, see *Network Setup menu* on page 71.

LAN terminal specifications

- LAN terminal : Ethernet jack (10BASE-T/100BASE-TX)



Note

- Refer to the operation manual of the equipment you have as the connected equipment and connection method may differ depending on your Internet environment.
- When using a broadband Internet connection, a contract with an Internet service provider is required. For more details, contact your nearest Internet service provider.

Connecting optional Bluetooth ADAPTER

When the *Bluetooth*® ADAPTER (AS-BT100 or AS-BT200) is connected to this receiver, a product equipped with *Bluetooth* wireless technology (portable cell phone, digital music player, etc.) can be used to listen to music wirelessly.

- The *Bluetooth* wireless technology enabled device must support A2DP profiles.
- Pioneer does not guarantee proper connection and operation of this unit with all *Bluetooth* wireless technology enabled devices.

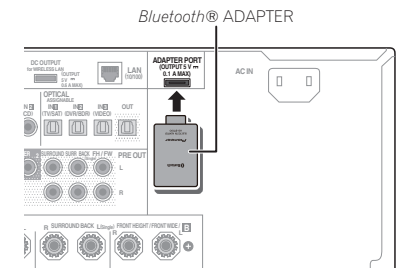



Important

- Do not move the receiver with the *Bluetooth ADAPTER* connected. Doing so could cause damage or faulty contact.
- Switch the receiver into standby and connect *Bluetooth ADAPTER* to the ADAPTER PORT.**
- For instructions on playing the *Bluetooth* wireless technology device, see *Pairing the Bluetooth ADAPTER and Bluetooth wireless technology device* on page 35.

Connecting an iPod

This receiver has a dedicated iPod terminal that will allow you to control playback of audio content from your iPod using the controls of this receiver.

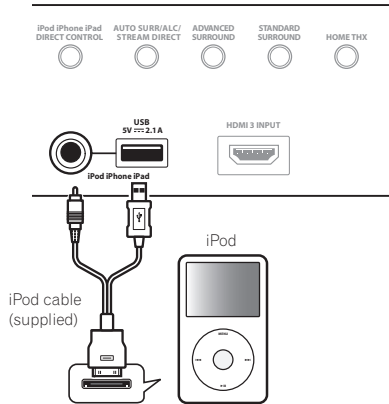

- Switch the receiver into standby then use the supplied iPod cable to connect your iPod to the iPod/iPhone/iPad USB terminal on the front panel of this receiver.**
- It is also possible to connect using the cable included with the iPod, but in this case it is not possible to view pictures via the receiver.
- For the cable connection, also refer to the operating instructions for your iPod.
- For instructions on playing the iPod, see *Playing an iPod* on page 30.

Connecting a USB device

It is possible to play audio and photo files by connecting USB devices to this receiver. It is also possible to connect a USB keyboard (US-international layout) to the receiver to enter text in the following GUI screens.

- Change the input name in the **Input Setup** menu (page 28).
- Add names to radio station presets (page 33).

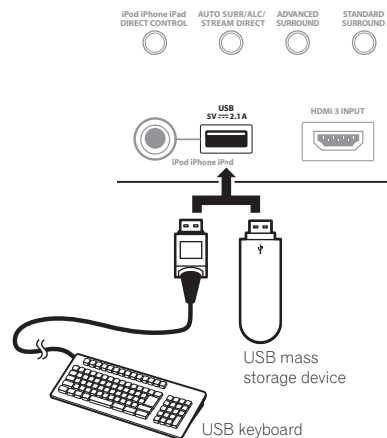

- Switch the receiver into standby then connect your USB device to the USB terminal on the front panel of this receiver.**
- This receiver does not support a USB hub.
- For instructions on playing the USB device, see *Playing a USB device* on page 31.

Connecting an HDMI-equipped component to the front panel input

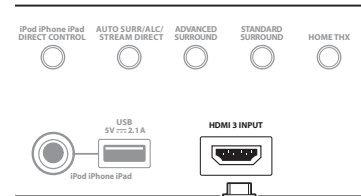

Connecting to a wireless LAN

Wireless connection to the network is possible through a wireless LAN connection. Use the separately sold AS-WL300 for connection.

- For instructions on setting the wireless LAN converter, see *Network Setup menu* on page 71.

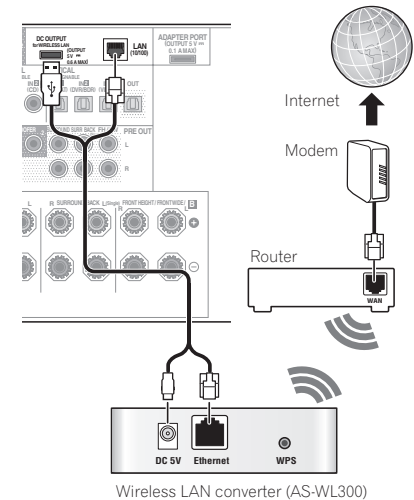

Connecting an IR receiver

If you keep your stereo components in a closed cabinet or shelving unit, or you wish to use the sub zone remote control in another zone, you can use an optional IR receiver (such as a Niles or Xantech unit) to control your system instead of the remote sensor on the front panel of this receiver.

- Remote operation may not be possible if direct light from a strong fluorescent lamp is shining on the IR receiver remote sensor window.
- Note that other manufacturers may not use the IR terminology. Refer to the manual that came with your component to check for IR compatibility.
- If using two remote controls (at the same time), the IR receiver's remote sensor takes priority over the remote sensor on the front panel.

1 Connect the IR receiver sensor to the IR IN jack on the rear of this receiver.

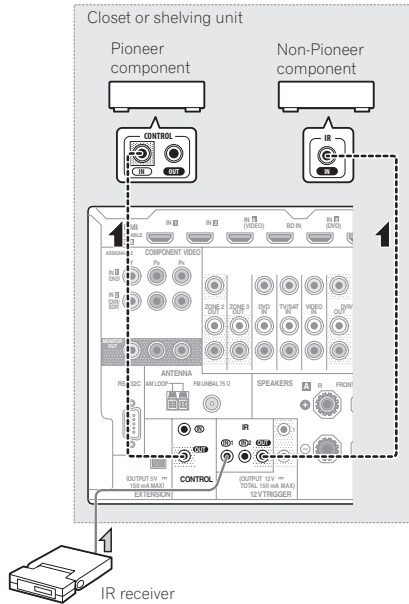

2 Connect the IR IN jack of another component to the IR OUT jack on the rear of this receiver to link it to the IR receiver.

Please see the manual supplied with your IR receiver for the type of cable necessary for the connection.

- If you want to link a Pioneer component to the IR receiver, see *Operating other Pioneer components with this unit's sensor* on page 24 to connect to the **CONTROL** jacks instead of the **IR OUT** jack.

Operating other Pioneer components with this unit's sensor

Many Pioneer components have **SR CONTROL** jacks which can be used to link components together so that you can use just the remote sensor of one component. When you use a remote control, the control signal is passed along the chain to the appropriate component.

- If you want to control all your components using this receiver's remote control, see page 56.
- If you have connected a remote control to the **CONTROL IN** jack (using a mini-plug cable), you won't be able to control this unit using the remote sensor.

Important

- Note that if you use this feature, *make sure that you also have at least one set of analog audio, video or HDMI jacks connected to another component for grounding purposes.*

1 Decide which component you want to use the remote sensor of.

When you want to control any component in the chain, this is the remote sensor at which you'll point the corresponding remote control.

2 Connect the CONTROL OUT jack of that component to the CONTROL IN jack of another Pioneer component.

Use a cable with a mono mini-plug on each end for the connection.

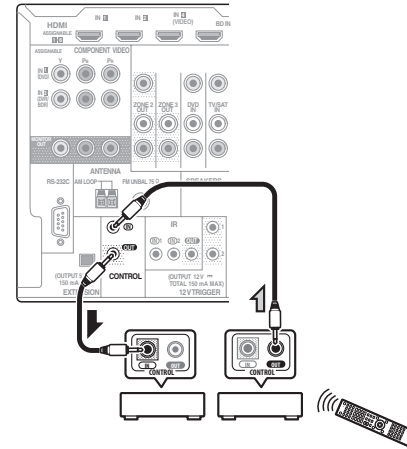

3 Continue the chain in the same way for as many components as you have.

Switching components on and off using the 12 volt trigger

You can connect components in your system (such as a screen or projector) to this receiver so that they switch on or off using 12 volt triggers when you select an input function. However, you must specify which input functions switch on the trigger using the *The Input Setup menu* on page 28. Note that this will only work with components that have a standby mode.

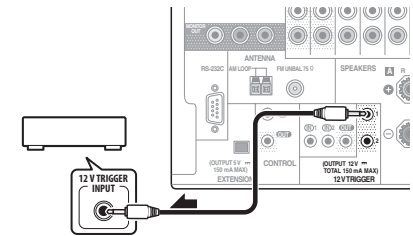

- **Connect the 12 V TRIGGER jack of this receiver to the 12 V trigger of another component.**

Use a cable with a mono mini-plug on each end for the connection.

After you've specified the input functions that will switch on the trigger, you'll be able to switch the component on or off just by pressing the input function(s) you've set on page 28.

Note

- *V SX-53 only:*
It is also possible to have the component switch not when the input function is switched, but when **HDMI OUT** is switched. For details, see *HDMI Setup* on page 47.

Plugging in the receiver

Only plug in after you have connected all your components to this receiver, including the speakers.

CAUTION

- Handle the power cord by the plug part. Do not pull out the plug by tugging the cord, and never touch the power cord when your hands are wet, as this could cause a short circuit or electric shock. Do not place the unit, a piece of furniture, or other object on the power cord or pinch the cord in any other way. Never make a knot in the cord or tie it with other cables. The power cords should be routed so that they are not likely to be stepped on. A damaged power cord can cause a fire or give you an electric shock. Check the power cord once in a while. If you find it damaged, ask your nearest Pioneer authorized independent service company for a replacement.
- Do not use any power cord other than the one supplied with this unit.
- Do not use the supplied power cord for any purpose other than that described below.
- The receiver should be disconnected by removing the mains plug from the wall socket when not in regular use, e.g., when on vacation.
- Make sure the blue  **STANDBY/ON** light has gone out before unplugging.
- If you have connected speakers with a 6 Ω impedance, change the impedance setting before turning on the power.

1 Plug the supplied power cord into the AC IN socket on the back of the receiver.

2 Plug the other end into a power outlet.

- After this receiver is connected to an AC outlet, a 2 second to 10 second HDMI initialization process begins. You cannot carry out any operations during this process. The **HDMI** indicator in the front panel display blinks during this process, and you can turn on this receiver once it has stopped blinking. When you set the **Control** with HDMI to **OFF**, you can skip this process. For details about the **Control** with HDMI feature, see *Control with HDMI function* on page 47 .

Basic Setup

Switching the speaker impedance

We recommend using speakers of 8 Ω with this system, but it is possible to switch the impedance setting if you plan to use speakers with a 6 Ω impedance rating.

- 1 Switch the receiver into standby.
- 2 While holding down ENTER on the front panel, press **STANDBY/ON**. The display shows **RESET ◀ NO ▶**.
- 3 Use **TUNE ↑/↓** to select **SPEAKER ◀ 8Ω ▶**, and then use **PRESET ◀/▶** to select **SPEAKER 8Ω** or **SPEAKER 6Ω**.
 - **SPEAKER 8Ω** – Use this setting if your speakers are rated at 8 Ω or more.
 - **SPEAKER 6Ω** – Use this setting if your speakers are rated at 6 Ω.

Changing the OSD display language (OSD Language)

The language used on the Graphical User Interface screen can be changed.

- The explanations in these operating instructions are for when English is selected for the GUI screen.

1 Press **RECEIVER** to switch on the receiver and your TV.

Make sure that the TV's video input is set to this receiver (for example, if you connected this receiver to the **VIDEO** jacks on your TV, make sure that the **VIDEO** input is now selected).

2 Press **RECEIVER** on the remote control, then press **HOME MENU**.

A Graphical User Interface (GUI) screen appears on your TV. Use **↑/↓/◀/▶** and **ENTER** to navigate through the screens and

select menu items. Press **RETURN** to exit the current menu.

3 Select 'System Setup' from the Home Menu.

4 Select 'OSD Language' from the System Setup menu.

5 Select the desired language.

6 Select 'OK' to change the language.

The setting is completed and the **System Setup** menu reappears automatically.

Automatically conducting optimum sound tuning (Full Auto MCACC)

The Full Auto MCACC Setup measures the acoustic characteristics of your listening area, taking into account ambient noise, speaker connection and speaker size, and tests for both channel delay and channel level. After you have set up the microphone provided with your system, the receiver uses the information from a series of test tones to optimize the speaker settings and equalization for your particular room. *VSX-53 only:* By performing the Full Auto MCACC Setup procedure, the frequency-phase characteristics of the connected speakers are also calibrated.

Once the Full Auto MCACC Setup procedure is completed, the Full Band Phase Control function is automatically turned on (page 39).

Important

- Make sure the microphone and speakers are not moved during the Full Auto MCACC Setup.
- Using the Full Auto MCACC Setup will overwrite any existing settings for the MCACC preset you select.

- Before using the Full Auto MCACC Setup, the headphones should be disconnected.

CAUTION

- The test tones used in the Full Auto MCACC Setup are output at high volume.

THX®

- THX is a trademark of THX Ltd., which may be registered in some jurisdictions. All rights reserved.

1 Press **RECEIVER** to switch on the receiver and your TV.

Make sure that the TV's video input is set to this receiver.

2 Connect the microphone to the MCACC SETUP MIC jack on the front panel.

Push down on the lower portion of the front panel door to access the **MCACC SETUP MIC** jack.

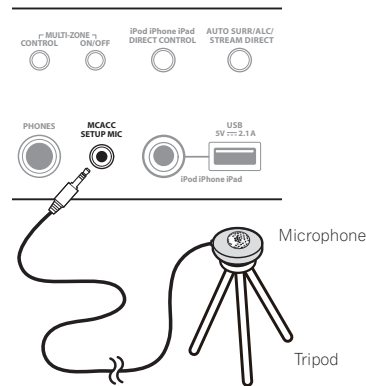

Make sure there are no obstacles between the speakers and the microphone.

If you have a tripod, use it to place the microphone so that it's about ear level at your normal listening position. If you do not have a tripod, use some other object to install the microphone.

Install the microphone on a stable floor. Placing the microphone on any of the following surfaces may make accurate measurement impossible:

- Sofas or other soft surfaces.
- High places such as tabletops and sofa tops.

The Full Auto MCACC display appears once the microphone is connected.

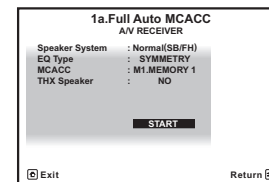

- If you leave the GUI screen for over five minutes, the screen saver will appear.

3 Select the parameters you want to set.

- When data measurement is taken, the reverb characteristics data (both before- and after-calibration) that this receiver had been storing will be overwritten.
- When measurement is taken of the reverb characteristics data other than **SYMMETRY**, the data are not measured after the correction. If you will need to measure after correcting data, take the measurement using the **EQ Professional** menu in the **Manual MCACC** setup (page 64).

If the speakers are connected using any setup other than **Normal(SB/FH)**, be sure to set **Speaker System** before the Full Auto MCACC Setup. See *Speaker system setting* on page 69.

- **Speaker System** – Shows the current settings. When this is selected and **ENTER** is pressed, the speaker system selection screen appears. Select the proper speaker system, then press **RETURN** to return. If you are planning on bi-amping your front speakers, or setting up a separate speaker system in another room, read through *Speaker system setting* on page 69 and make

sure to connect your speakers as necessary before continuing to step 4.

- **EQ Type** – This determines how the frequency balance is adjusted.
- **MCACC** – The six MCACC presets are used for storing surround sound settings for different listening positions. Simply choose an unused preset for now (you can rename it later in *Data Management* on page 67).
- **THX Speaker** – Select **YES** when using THX speakers (all speakers other than the front speakers are set to **SMALL**). In other cases, leave at **NO**.

4 Press **RECEIVER** then select **START**.

5 Follow the instructions on-screen.

Make sure the microphone is connected, and if you're using a subwoofer, make sure it is switched on and set to a comfortable volume level.

6 Wait for the test tones to finish, then confirm the speaker configuration in the GUI screen.

A progress report is displayed on-screen while the receiver outputs test tones to determine the speakers present in your setup. Try to be as quiet as possible while it's doing this. If no operations are performed for 10 seconds while the speaker configuration check screen is being displayed, the Full Auto MCACC Setup will resume automatically. In this case, you don't need to select '**OK**' and press **ENTER** in step 7.

- With error messages (such as **Too much ambient noise!** or **Check microphone.**), select **RETRY** after checking for ambient noise (see *Problems when using the Auto MCACC Setup* on page 27) and verifying the mic connection. If there doesn't seem to be a problem, you can simply select **GO NEXT** and continue.

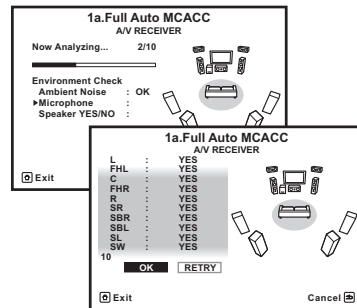

The configuration shown on-screen should reflect the actual speakers you have.

- If you see an **ERR** message (or the speaker configuration displayed isn't correct), there may be a problem with the speaker connection. If selecting **RETRY** doesn't work, turn off the power and check the speaker connections. If there doesn't seem to be a problem, you can simply use **↑/↓** to select the speaker and **←/→** to change the setting and continue.
- If the speaker is not pointed to the microphone (listening position) or when using speakers that affect the phase (dipole speakers, reflective speakers, etc.), **Reverse Phase** may be displayed even if the speakers are properly connected. If **Reverse Phase** is displayed, the speaker's wiring (+ and -) may be inverted. Check the speaker connections.
 - If the connections were wrong, turn off the power, disconnect the power cord, then reconnect properly. After this, perform the Full Auto MCACC procedure again.
 - If the connections were right, select **GO NEXT** and continue.

7 Make sure '**OK**' is selected, then press **ENTER**.

A progress report is displayed on-screen while the receiver outputs more test tones to determine the optimum receiver settings. Again, try to be as quiet as possible while this is happening. It may take 3 to 10 minutes.

8 The Full Auto MCACC Setup procedure is completed and the Home Menu menu reappears automatically.

Be sure to disconnect the microphone from this receiver upon completion of the Full Auto MCACC Setup.

The settings made in the Full Auto MCACC Setup should give you excellent surround sound from your system, but it is also possible to adjust these settings manually using *The Advanced MCACC menu* on page 62 or *The System Setup and Other Setup menus* on page 69 .

- Depending on the characteristics of your room, sometimes identical speakers with cone sizes of around 12 cm (5 inches) will end up with different size settings. You can correct the setting manually using the *Manual speaker setup* on page 69 .
- The subwoofer distance setting may be farther than the actual distance from the listening position. This setting should be accurate (taking delay and room characteristics into account) and generally does not need to be changed.
- If Full Auto MCACC Setup measurement results are incorrect due to the interaction of the speakers and viewing environment, we recommend adjusting the settings manually.

Problems when using the Auto MCACC Setup

If the room environment is not optimal for the Auto MCACC Setup (too much background noise, echo off the walls, obstacles blocking the speakers from the microphone) the final settings may be incorrect. Check for household appliances (air conditioner, fridge, fan, etc.), that may be affecting the environment and switch them off if necessary. If there are any instructions showing in the front panel display, please follow them.

- Some older TVs may interfere with the operation of the microphone. If this seems to be happening, switch off the TV when doing the Auto MCACC Setup.

The Input Setup menu

You only need to make settings in the **Input Setup** menu if you didn't hook up your digital equipment according to the default settings (see *Input function default and possible settings* on page 28). In this case, you need to tell the receiver what equipment is hooked up to which terminal so the buttons on the remote control correspond to the components you've connected.

1 Press **RECEIVER** on the remote control, then press **HOME MENU**.

A Graphical User Interface (GUI) screen appears on your TV. Use **↑/↓/←/→** and **ENTER** to navigate through the screens and select menu items. Press **RETURN** to exit the current menu.

2 Select 'System Setup' from the Home Menu.

3 Select 'Input Setup' from the System Setup menu.

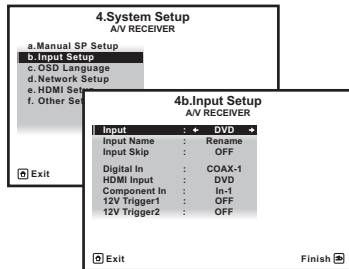

4 Select the input function that you want to set up.

The default names correspond with the names next to the terminals on the rear panel (such as **DVD** or **BD**) which, in turn, correspond with the names on the remote control.

5 Select the input(s) to which you've connected your component.

For example, if your DVD player only has an optical output, you will need to change the **DVD** input function's **Digital In** setting from **COAX-1** (default) to the optical input you've connected it to. The numbering (**OPT-1** to **OPT-2**) corresponds with the numbers beside the inputs on the back of the receiver.

6 When you're finished, proceed to the settings for other inputs.

There are optional settings in addition to the assignment of the input jacks:

- **Input Name** – You can choose to rename the input function for easier identification. Select **Rename** to do so, or **Default** to return to the system default.
- **Input Skip** – When set to **ON**, that input is skipped when selecting the input using **INPUT SELECT**. (**DVD** and other inputs can be still be selected directly with the input function buttons.)
- **12V Trigger1/2** – After connecting a component to one of the 12 volt triggers (see *Switching components on and off using the 12 volt trigger* on page 24), select **MAIN**, **ZONE 2**, **ZONE 3** (**VSX-53** only) or **OFF** for the corresponding trigger setting to switch it on automatically along with the (main or sub) zone specified.
 - **VSX-53 only:**
Devices connected to 12 volt triggers can be associated with **HDMI OUT** switching. For details, see *HDMI Setup* on page 47.

7 When you're finished, press **RETURN**.

You will return to the **System Setup** menu.

Input function default and possible settings

The terminals on the receiver generally correspond to the name of one of the input functions. If you have connected components to this receiver differently from (or in addition to) the defaults below, see *The Input Setup menu* on page 28 to tell the receiver how you've connected up. The dots (●) indicate possible assignments.

Input function	Input Terminals		
	HDMI	Digital	Component
BD	(BD)		
DVD	IN 5	COAX-1	IN 1
TV/SAT	● <a>	OPT-1	●
DVR/BDR	IN 6	OPT-2	IN 2
VIDEO	IN 4	OPT-3	●
HDMI 1	IN 1		
HDMI 2	IN 2		
HDMI 3 (front panel)	IN 3		
HOME MEDIA GALLERY			
iPod/USB			
CD		COAX-2	
TUNER			
ADAPTER PORT			
SIRIUS		●	

- a With **Control** with HDMI set to **ON**, assignments cannot be made (see *Control with HDMI function* on page 47).

Operation Mode Setup

This receiver is equipped with a great number of functions and settings. The Operation Mode feature is provided for users who find it difficult to master all these functions and settings. One of two settings can be selected for the **Operation Mode: Expert** and **Basic**.

1 Press **RECEIVER** on the remote control, then press **HOME MENU**.

A Graphical User Interface (GUI) screen appears on your TV. Use **↑/↓/←/→** and **ENTER** to navigate through the screens and select menu items. Press **RETURN** to exit the current menu.

2 Select 'Operation Mode Setup' from the Home Menu.

3 Select the Operation Mode setting you want.

- **Expert** (default) – Users can set all the functions by themselves.
- **Basic** – The number of operable functions is restricted, and functions whose operations are restricted are automatically set to achieve the Pioneer-recommended sound and picture quality. The functions that can be operated are shown below. They can be set as necessary by referring to the operating instructions.

Operable functions/items	Descriptions	Page
HOME MENU		
Full Auto MCACC	Makes high precision sound field settings easily.	26
Input Name	Input names can be changed as desired for easier use.	28
Input Skip	Inputs not being used are skipped (not displayed).	28

Operable functions/items	Descriptions	Page
Software Update	Updates to the latest version of the software.	74
Network Information	Checks the receiver's IP address.	73
Pairing Bluetooth Setup	Pairs with a Bluetooth device using AS-BT100 or AS-BT200.	35
Audio Parameters		
MCACC (MCACC preset)	Selects your favorite MCACC preset memory.	50
DELAY (Sound Delay)	Adjusts the delay time of the overall sound.	50
S.RTRV (Auto Sound Retriever)	Plays compressed sound with high sound quality.	50
DUAL (Dual Mono)	Dual monaural audio setting.	50
V.SB (Virtual Surround Back)	Creates a virtual surround back channel sound for playback.	50
V.HEIGHT (Virtual Height)	Creates a virtual height channel sound for playback.	50
V.DEPTH (Virtual Depth)	Plays with a sound field suited for 3D images.	50
Other functions		
INPUT SELECT (INPUT SELECTOR)	Switches the input.	30
MASTER VOLUME +/-, MUTE	Use to set the listening volume.	30
LISTENING MODE	Only Pioneer-recommended modes can be selected.	37
PQLS	Plays using the PQLS function.	48

Operable functions/items	Descriptions	Page
PHASE CTRL (Phase Control)	Plays with phase shifting in the low range corrected.	39
<i>VSX-53 only:</i> PHASE CTRL (Full Band Phase Control)	The Full Band Phase Control feature calibrates the frequency-phase characteristics of the speakers connected.	39
iPod iPhone iPad DIRECT CONTROL	Switches the input to iPod/USB and sets the mode allowing operation from the iPod.	31

4 When you're finished, press RETURN.

You will return to the **Home Menu**.

Basic playback

Playing a source

Here are the basic instructions for playing a source (such as a DVD disc) with your home theater system.

1 Switch on your system components and receiver.

Start by switching on the playback component (for example a DVD player), your TV and subwoofer (if you have one), then the receiver (press **⏻ RECEIVER**).

Make sure that the TV's video input is set to this receiver.

2 Select the input function you want to play.

You can use the input function buttons on the remote control, **INPUT SELECT**, or the front panel **INPUT SELECTOR** dial.

- If you need to manually switch the input signal type press **SIGNAL SEL** (page 39).

3 Press **RECEIVER** to the receiver operation mode.

4 Press **AUTO/ALC/DIRECT** (**AUTO SURR/ALC/STREAM DIRECT**) to select 'AUTO SURROUND' and start playback of the source.

If you're playing a Dolby Digital or DTS surround sound source, you should hear surround sound. If you are playing a stereo source, you will only hear sound from the front left/right speakers in the default listening mode.

- You may need to check the digital audio output settings on your DVD player or digital satellite receiver. It should be set to output Dolby Digital, DTS and 88.2 kHz / 96 kHz PCM (2 channel) audio, and if there is an MPEG audio option, set this to convert the MPEG audio to PCM.

- See also *Listening to your system* on page 37 for information on different ways of listening to sources.

It is possible to check on the front panel display whether or not multi-channel playback is being performed properly. For details, see *Auto Surround, ALC and Stream Direct with different input signal formats* on page 90.

When using a surround back speaker, **DIGITAL** is displayed when playing Dolby Digital 5.1 channel signals, and **DTS** is displayed when playing DTS 5.1-channel signals. If the display does not correspond to the input signal and listening mode, check the connections and settings.

5 Use the **MASTER VOLUME +/-** to adjust the volume level.

Turn down the volume of your TV so that all sound is coming from the speakers connected to this receiver.

Playing a source with HDMI connection

● Use **INPUT SELECT** to select the input function connected to the receiver's HDMI input terminals.

You can also perform the same operation by using the **INPUT SELECTOR** dial on the front panel or by pressing **HDMI** on the remote control repeatedly.

- Set the **HDMI** parameter in *Setting the Audio options* on page 50 to **THROUGH** if you want to hear HDMI audio output from your TV (no sound will be heard from this receiver).
- If the video signal does not appear on your TV, try adjusting the resolution settings on your component or display. Note that some components (such as video game units) have resolutions that may not be converted. In this case, use an analog video connection.

Playing an iPod

This receiver has the **iPod iPhone iPad USB** terminal that will allow you to control playback of audio content from your iPod using the controls of this receiver.

- This receiver is compatible with the audio and video of the iPod nano (audio only for the iPod nano 1G/2G), iPod fifth generation (audio only), iPod classic, iPod touch, iPhone and iPad. However, some of the functions may be restricted for some models. The receiver is not compatible with the iPod shuffle.
- This receiver has been developed and tested for the software version of iPod/iPhone/iPad indicated on the website of Pioneer (<http://pioneer.jp/homeav/support/ios/na/>).
- Installing software versions other than indicated on the website of Pioneer to your iPod/iPhone/iPad may result in incompatibility with this receiver.
- iPod, iPhone and iPad are licensed for reproduction of non-copyrighted materials or materials the user is legally permitted to reproduce.
- Features such as the equalizer cannot be controlled using this receiver, and we recommend switching the equalizer off before connecting.
- Pioneer cannot under any circumstances accept responsibility for any direct or indirect loss arising from any inconvenience or loss of recorded material resulting from the iPod failure.
- When listening to a track on the iPod in the main zone, it is possible to control the sub zone, but not to listen to a different track in the sub zone from the one playing in the main zone.

1 Press **⏻ RECEIVER** to switch on the receiver and your TV.

See *Connecting an iPod* on page 23.

- It is also possible to operate the iPod on the iPod itself, without using the TV screen. For details, see *Switching the iPod controls* on page 31.

2 Press **iPod USB** on the remote control to switch the receiver to the iPod/USB.

Loading appears in the GUI screen while the receiver verifies the connection and retrieves data from the iPod.

When the display shows the **iPod Top** menu you're ready to play music from the iPod.

- The controls of your iPod will be inoperable when connected to this receiver.

Playing back audio files stored on an iPod

To navigate songs on your iPod, you can take advantage of the GUI screen of your TV connected to this receiver. You can also control all operations for music in the front panel display of this receiver.

- Note that characters that cannot be displayed on this receiver are displayed as #.
- This feature is not available for photos on your iPod. To display photos, switch iPod operation to the iPod (see *Switching the iPod controls* on page 31).

Finding what you want to play

When your iPod is connected to this receiver, you can browse songs stored on your iPod by playlist, artist name, album name, song name, genre or composer, similar to using your iPod directly.

1 Use **↑/↓** to select 'Music' from the iPod Top menu.

2 Use \uparrow/\downarrow to select a category, then press ENTER to browse that category.

- To return to the previous level any time, press RETURN.

3 Use \uparrow/\downarrow to browse the selected category (e.g., albums).

- Use \leftarrow/\rightarrow to move to previous/next levels.

4 Continue browsing until you arrive at what you want to play, then press \blacktriangleright to start playback.



Note

- You can play all of the songs in a particular category by selecting the **All** item at the top of each category list. For example, you can play all the songs by a particular artist.

Basic playback controls

This receiver's remote control buttons can be used for basic playback of files stored on an iPod.

- Press **iPod USB** to switch the remote control to the iPod/USB operation mode.

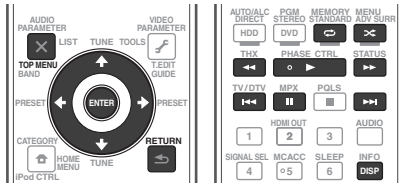

- During Audiobook playback, press \uparrow/\downarrow to switch the playback speed: Faster \leftrightarrow Normal \leftrightarrow Slower.

Switching the iPod controls

You can switch over the iPod controls between the iPod and the receiver.

- You cannot use this function, when an iPod of fifth generation or iPod nano of first generation is connected.

1 Press iPod CTRL to switch the iPod controls.

This enables operation and display on your iPod, and this receiver's remote control and GUI screen become inactive.

2 Press iPod CTRL again to switch back to the receiver controls.



Note

- Change the receiver's input to the iPod in one action by pressing the **iPod iPhone iPad DIRECT CONTROL** button on the front panel to enable iPod operations on the iPod.

Playing a USB device

It is possible to play files using the USB interface on the front of this receiver.

- Compatible USB devices include external magnetic hard drives, portable flash memory drives (particularly key drives) and digital audio players (MP3 players) of format FAT16/32.
- Pioneer cannot guarantee compatibility (operation and/or bus power) with all USB mass storage devices and assumes no responsibility for any loss of data that may occur when connected to this receiver.

1 Press \odot RECEIVER to switch on the receiver and your TV.

See *Connecting a USB device* on page 23.

- Make sure the receiver is in standby when disconnecting the USB device.

2 Press iPod USB on the remote control to switch the receiver to the iPod/USB.

Loading appears in the GUI screen as this receiver starts recognizing the USB device connected. When the display shows the **USB Top** menu you're ready to play from the USB device.



Note

If an **Over Current** message lights in the display, the power requirements of the USB device are too high for this receiver. Try following the points below:

- Switch the receiver off, then on again.
- Reconnect the USB device with the receiver switched off.
- Use a dedicated AC adapter (supplied with the device) for USB power.

If this doesn't remedy the problem, it is likely your USB device is incompatible.

Playing back audio files stored on a USB memory device

The maximum number of levels that you can select in Step 2 (below) is 8. Also, you can display and play back up to 30 000 folders and files within a USB memory device.

- Note that non-Roman characters in the playlist are displayed as #.

1 Use \uparrow/\downarrow to select 'Music' from the USB Top menu.

2 Use \uparrow/\downarrow to select a folder, then press ENTER to browse that folder.

- To return to the previous level any time, press RETURN.

3 Continue browsing until you arrive at what you want to play, then press \blacktriangleright to start playback.

- Copyrighted audio files cannot be played back on this receiver.
- DRM-protected audio files cannot be played back on this receiver.

Basic playback controls

This receiver's remote control buttons can be used for basic playback of files stored on USB memory devices.

- Press **iPod USB** to switch the remote control to the iPod/USB operation mode.

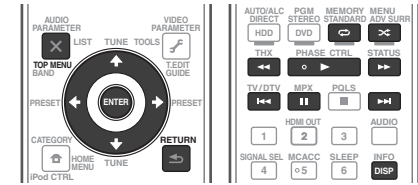

Playing back photo files stored on a USB memory device

- Photo files cannot be played in the sub zone.

1 Use \uparrow/\downarrow to select 'Photos' from the USB Top menu.

2 Use \uparrow/\downarrow to select a folder, then press ENTER to browse that folder.

- To return to the previous level any time, press RETURN.

3 Continue browsing until you arrive at what you want to play, then press \blacktriangleright to start playback.

The selected content is displayed in full screen and a slideshow starts.

After a slideshow launches, pressing ENTER toggles between play and pause (only when

Theme on the Slideshow Setup is set to **Normal (OFF)**).

- If the slideshow is left in the pause mode for five minutes, the list screen reappears.

Basic playback controls

Button(s)	What it does
ENTER, \blacktriangleright	Starts displaying a photo and playing a slideshow.
RETURN, \leftarrow	Stops the player and returns to the previous menu.
\lll <a>	Displays the previous photo content.

Button(s)	What it does
▶▶ <a>	Displays the next photo content.
 <a>	Pauses/unpauses the slideshow.
DISP <a>	Displays the photo information.

a You can only use this button when **Theme** on the **Slideshow Setup** is set to **Normal (OFF)**.

Slideshow Setup

Make the various settings for playing slide-shows of photo files here.

1 Use ↑/↓ to select 'Slideshow Setup' from the USB Top menu.

2 Select the setting you want.

- **Theme** – Add various effects to the slideshow.
- **Interval** – Set the interval for switching the photos. This may not be available depending on the **Theme** setting.
- **BGM** – Play music files stored on the USB device while displaying photos.
- **Music Select** – Select the folder containing the music files to be played when **BGM** is set to **ON**.

3 When you're finished, press RETURN.

You will return to the **USB Top** menu.

About playable file formats

The USB function of this receiver supports the following file formats. Note that some file formats are not available for playback although they are listed as playable file formats.

Music files

Category	Extension		Stream	
MP3 <a>	.mp3	MPEG-1, 2, 2.5 Audio Layer-3	Sampling frequency	8 kHz to 48 kHz
			Quantization bitrate	16 bit
			Channel	2 ch
			Bitrate	8 kbps to 320 kbps
			VBR/CBR	Supported/Supported
WAV	.wav	LPCM	Sampling frequency	32 kHz, 44.1 kHz, 48 kHz
			Quantization bitrate	8 bit, 16 bit
			Channel	2 ch, Monaural
WMA	.wma	WMA8/9 	Sampling frequency	8 kHz to 48 kHz
			Quantization bitrate	16 bit
			Channel	2 ch
			Bitrate	8 kbps to 320 kbps
			VBR/CBR	Supported/Supported

a "MPEG Layer-3 audio decoding technology licensed from Fraunhofer IIS and Thomson multimedia."

b Files encoded using Windows Media Codec 9 may be playable but some parts of the specification are not supported; specifically, Pro, Lossless, Voice.

Photo files

Category	Extension			
JPEG	.jpg .jpeg .jpe .jif .jfif	Format	Meeting the following conditions:	
			• Baseline JPEG format (including files recorded in Exif/DCF format)	
			• Y:Cb:Cr - 4:4:4, 4:2:2 or 4:2:0	
			Resolution	30 to 8184 pixels vertical, 40 to 8184 pixels horizontal

Listening to the radio

The following steps show you how to tune in to FM and AM radio broadcasts using the automatic (search) and manual (step) tuning functions. If you already know the frequency of the station you want, see Tuning directly to a station below. Once you are tuned to a station you can memorize the frequency for recall later—see *Saving station presets* on page 33 for more on how to do this.

- 1 Press **TUNER** to select the tuner.
- 2 Use **BAND** to change the band (FM or AM), if necessary.
- 3 Tune to a station.

There are three ways to do this:

- **Automatic tuning** – To search for stations in the currently selected band, press and hold **TUNE** \uparrow/\downarrow for about a second. The receiver will start searching for the next station, stopping when it has found one. Repeat to search for other stations.
- **Manual tuning** – To change the frequency one step at a time, press **TUNE** \uparrow/\downarrow .
- **High speed tuning** – Press and hold **TUNE** \uparrow/\downarrow for high speed tuning. Release the button at the frequency you want.

Improving FM sound

If the **TUNED** or **STEREO** indicator doesn't light when tuning to an FM station because the signal is weak, press **MPX** to switch the receiver into mono reception mode. This should improve the sound quality and allow you to enjoy the broadcast.

Using Neural Surround

This feature uses Neural Surround™ technologies to achieve optimal surround sound from FM radio.

- While listening to FM radio, press **AUTO/ALC/DIRECT** for Neural Surround.
- The **Neural Surround** mode can be selected also with **STANDARD**.

Tuning directly to a station

- 1 Press **TUNER** to select the tuner.
- 2 Use **BAND** to change the band (FM or AM), if necessary.
- 3 Press **D.ACCESS (Direct Access)**.
- 4 Use the number buttons to enter the frequency of the radio station.

For example, to tune to **106.00** (FM), press **1**, **0**, **6**, **0**, **0**.

If you make a mistake halfway through, press **D.ACCESS** twice to cancel the frequency and start over.

Saving station presets

If you often listen to a particular radio station, it's convenient to have the receiver store the frequency for easy recall whenever you want to listen to that station. This saves the effort of manually tuning in each time. This receiver can memorize up to 63 stations, stored in seven banks, or classes (A to G) of 9 stations each.

- 1 Tune to a station you want to memorize.

See *Listening to the radio* on page 33 for more on this.

- 2 Press **T.EDIT (TUNER EDIT)**.

The display shows **PRESET MEMORY**, then a blinking memory class.

- 3 Press **CLASS** to select one of the seven classes, then press **PRESET** \leftarrow/\rightarrow to select the station preset you want.

You can also use the number buttons to select a station preset.

- 4 Press **ENTER**.

After pressing **ENTER**, the preset class and number stop blinking and the receiver stores the station.

Listening to station presets

- 1 Press **TUNER** to select the tuner.
 - 2 Press **CLASS** to select the class in which the station is stored.
- Press repeatedly to cycle through classes A to G.
- 3 Press **PRESET** \leftarrow/\rightarrow to select the station preset you want.

- You can also use the number buttons on the remote control to recall the station preset.

Naming station presets

For easier identification, you can name your station presets.

- 1 Choose the station preset you want to name.

See *Listening to station presets* on page 33 for how to do this.

- 2 Press **T.EDIT (TUNER EDIT)**.

The display shows **PRESET NAME**, then a blinking cursor at the first character position.

- 3 Input the name you want.

Use \uparrow/\downarrow to select a character, \leftarrow/\rightarrow to set the position, and **ENTER** to confirm your selection.



Note

- To erase a station name, simply repeat steps 1 to 3 and input eight spaces instead of a name.
- Once you have named a station preset, you can press **DISP** when listening to a station to switch the display between name and frequency.

Listening to Satellite Radio

To listen to Satellite Radio, you'll need to connect a SIRIUS Satellite Radio tuner (sold separately) to your Sirius-Ready receiver. SIRIUS Satellite Radio is available to residents of the US (except Alaska and Hawaii) and Canada. Satellite Radio delivers a variety of commercial-free music from categories ranging from Pop, Rock, Country, R&B, Dance, Jazz, Classical and many more plus coverage of all the top professional and college sports including play by play games from select leagues and teams. Additional programming includes expert sports talk, uncensored entertainment, comedy, family programming, local traffic and weather and news from your most trusted sources.

Once you've purchased a SIRIUS tuner you'll need to activate it and subscribe to begin enjoying the service. Easy to follow installation and setup instructions are provided with the SIRIUS tuner. There are a variety of programming packages available, including the option of adding "The Best of XM" programming to the SIRIUS service. The "Best of XM" service is not available to SIRIUS Canada subscribers at this time. Please check with SIRIUS Canada for any updates using the numbers and web address below.

Family friendly packages are also available to restrict channels featuring content that may be inappropriate for children.

To subscribe to SIRIUS, U.S. and Canadian customers can call 1-888-539-SIRI (1-888-539-7474) or visit sirius.com (US) or siriuscanada.ca (Canada).

SIRIUS, XM and all related marks and logos are trademarks of Sirius XM Radio Inc. and its subsidiaries. All rights reserved. Service not available in Alaska and Hawaii.

● Press **SIRIUS** to switch to the SIRIUS input.

For best reception, you may need to move the SiriusConnect™ tuner antenna near a window (refer to the manual for the SiriusConnect™ Home tuner for antenna placement recommendations).

- If after pressing **SIRIUS** the display shows **Antenna Error**, try disconnecting the antenna and reconnecting. If the display shows **Check Sirius Tuner**, check the connection of the AC adapter and this receiver to the SiriusConnect™ tuner.
- You can check the strength of reception in *Using the SIRIUS Menu* on page 34 .



Note

- In order to activate your radio subscription, you will need the SIRIUS ID (SID) which uniquely identifies your tuner. The SID may be found on a sticker located on the packaging, or on the bottom of the tuner itself. The label will have a printed 12-digit SID number. When you have located the SID, write it down in the space provided near the end of this manual. Contact SIRIUS on the internet at: <https://activate.siriusradio.com>
- Follow the prompts to activate your subscription, or you can also call SIRIUS toll-free at 1-888-539-SIRIUS (1-888-539-7474).
- Select **0 (SIRIUS ID)** from the GUI screen to check the Radio ID of the SIRIUS Connect tuner (see *Selecting channels and browsing by genre* on page 34).

Listening to SIRIUS Radio

After connecting, you will be able to use this receiver to select channels and navigate categories using the GUI screen.

- It's easiest if you have your TV switched on to take advantage of the GUI screens. You can, however, use just the front panel display to do everything if you prefer.

Selecting channels and browsing by genre

From the SIRIUS Channel Guide, you can browse SIRIUS Radio channels in the order that they appear, or you can narrow your channel search by genre.

● Press **↑/↓** to enter the SIRIUS Channel Guide, then navigate through the channels one at time with **↑/↓**, then press **ENTER** to listen to the SIRIUS radio broadcast.

- To browse by genre, first press **CATEGORY**, use **↑/↓** to select a genre, then press **ENTER**.
- To cancel and exit any time, press **RETURN**.



Note

- You can select channels directly by pressing **D.ACCESS**, then the three-digit channel number.
- You can press **DISP** to change SIRIUS Radio information in the front panel display.
- The currently selected channel is automatically chosen (without pressing **ENTER**) after 10 seconds.

Saving channel presets

This receiver can memorize up to 63 channels, stored in seven banks, or classes (A to G) of 9 channels each.

1 Select the channel you want to memorize.

See *Selecting channels and browsing by genre* on page 34 .

2 Press **T.EDIT (TUNER EDIT)**.

The display shows a blinking memory class.

3 Press **CLASS** to select one of the seven classes, then press **←/→** to select the channel preset you want.

You can also use the number buttons to select a station preset.

4 Press **ENTER**.

After pressing **ENTER**, the preset class and number stop blinking and the receiver stores the SIRIUS channel.



Note

- You can also press **MEMORY** during reception display to save the information of up to five songs. See *Using the SIRIUS Menu* on page 34 to recall this information.
- You can reset the Channel presets, Memory, Channel Skip/Add, Parental Lock and Password settings in *Resetting the system* on page 55 .

Listening to channel presets

1 Press **CLASS** to select the class in which the channel is stored.

Press repeatedly to cycle through classes A to G.

2 Press **←/→** to select the channel preset you want.

You can also use the number buttons on the remote control to recall the channel preset.

Using the SIRIUS Menu

The SIRIUS Menu provides additional SIRIUS Radio features.

1 Press **TOP MENU**.

2 Use **↑/↓** to select a menu item, then press **ENTER**.

Choose from the following menu items:

- **Channel Skip/Add** – Use **↑/↓** and **ENTER** to select channels you would like to remove/restore from/to the channel guide.
- **Parental Lock** – Use **↑/↓** and **ENTER** to select channels you would like to place under parental lock. Channels put under parental lock are not displayed in the Channel Guide, but may be accessed by directly inputting their channel number and providing the parental lock password.

- **Antenna Aiming** – Check the strength of satellite and terrestrial reception.
- **Memory Recall** – Use **↑/↓** to browse your saved song information.
- **Password Set** – Set the parental lock password.

3 When you're finished press **TOP MENU** to return to the reception display.

Bluetooth ADAPTER for Wireless Enjoyment of Music

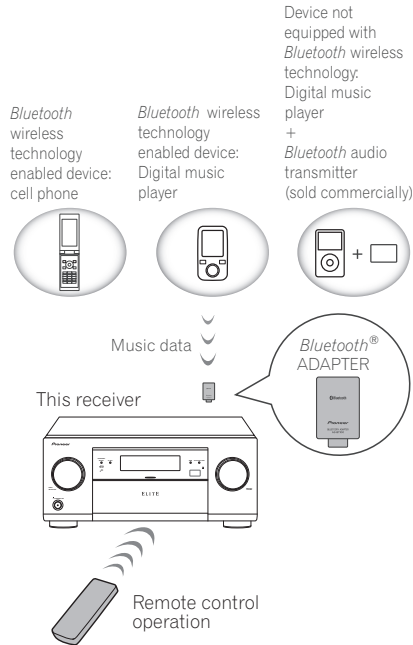

Wireless music play

When the *Bluetooth* ADAPTER (AS-BT100 or AS-BT200) is connected to this unit, a product equipped with *Bluetooth* wireless technology (portable cell phone, digital music player, etc.) can be used to listen to music wirelessly. Also, by using a commercially available transmitter supporting *Bluetooth* wireless technology, you can listen to music on a device not equipped with *Bluetooth* wireless technology. The AS-BT100 and AS-BT200 models supports SCMS-T contents protection, so music can also

be enjoyed on devices equipped with SCMS-T type *Bluetooth* wireless technology.

- With the AS-BT100, some functions may not be available on this receiver.

Remote control operation

The remote control supplied with this unit allows you to play and stop media, and perform other operations.

- It must be necessary that the *Bluetooth* wireless technology enabled device supports AVRCP profiles.
- Remote control operations cannot be guaranteed for all *Bluetooth* wireless technology enabled devices.

Pairing the Bluetooth ADAPTER and Bluetooth wireless technology device

"Pairing" must be done before you start playback of *Bluetooth* wireless technology content using the *Bluetooth* ADAPTER. Make sure to perform pairing the first time you operate the system or any time pairing data is cleared. The pairing step is necessary to register the *Bluetooth* wireless technology device to enable *Bluetooth* communications. For more details, see also the operating instructions of your *Bluetooth* wireless technology device.

- Pairing is required when you first use the *Bluetooth* wireless technology device and *Bluetooth* ADAPTER.
- To enable *Bluetooth* communication, pairing should be done with both your system and *Bluetooth* wireless technology device.
- If the *Bluetooth* wireless technology device's security code is "0000", there is no need to make the security code setting on the receiver. Press **ADPT** to set the **ADAPTER PORT** input, then conduct the pairing operation on the *Bluetooth* wireless technology device.

If pairing is successful, there is no need to performing the pairing operation below.

- When using the AS-BT200 only: This unit complies with *Bluetooth* Specifications Ver. 2.1. When this unit and another device equipped with *Bluetooth* wireless technology both comply with *Bluetooth* Specification Ver. 2.1, pairing of the two may be possible without the need for inputting a password. In this case, a passcode may be displayed on this receiver and on the device equipped with *Bluetooth* wireless technology. If this happens, check that the same passcode is displayed on this receiver and the device equipped with *Bluetooth* wireless technology, then select **YES** with the **←** and **→** keys and press **ENTER**. After this, also perform the connection operation on the *Bluetooth* device to be connected. If the passcode does not match the code displayed on the *Bluetooth* device to be connected, select **NO** to cancel pairing, then try starting over. Press **ADPT** to set the **ADAPTER PORT** input, then conduct the pairing operation on the *Bluetooth* wireless technology device. If pairing is successful, there is no need to performing the pairing operation below.
- Pair one unit at a time.
- When connecting this receiver by *Bluetooth* connections with a device equipped with the *Bluetooth* function to listen to music, do not connect any devices other than this receiver by *Bluetooth* connection to the *Bluetooth*-equipped device. If a *Bluetooth* connection is already established with a device other than this receiver, disconnect the other device before connecting this receiver.

- 1 Press **RECEIVER** on the remote control, then press **HOME MENU**.
- 2 Select '**System Setup**', then press **ENTER**.
- 3 Select '**Other Setup**', then press **ENTER**.

4 Select '**Pairing Bluetooth Device**', then press **ENTER**.

5 Select the '**Passcode**' setting you want. Select the same passcode as the *Bluetooth* wireless technology device you wish to connect.

- **0000/1234/8888** – Select the passcode from these options. These are the passcodes that can be used in most cases.
- **Others** – Select to use a passcode other than those mentioned above.

6 If you selected '**Others**' in step 5, enter the passcode.

Use **↑/↓** to select a number and **←/→** to move the cursor.

7 Follow the instructions displayed on the GUI screen to conduct pairing with the *Bluetooth* wireless technology device.

Switch on the *Bluetooth* wireless technology device that you want to make pair, place it near the receiver and set it to the pairing mode.

8 Check to see that the *Bluetooth* ADAPTER is detected by the *Bluetooth* wireless technology device.

When the *Bluetooth* wireless technology device is connected:

CONNECTED appears in the receiver display.

- The system can display alphanumeric characters only. Other characters may not be displayed correctly.

When the *Bluetooth* wireless technology device is not connected:

Go back to the passcode setting in step 5. In this case, perform the connection operation from the *Bluetooth* wireless technology device.

9 From the *Bluetooth* wireless technology device list, select *Bluetooth* ADAPTER and enter the Passcode selected in step 5.

- The passcode may in some cases be referred to as **PASSKEY** or **PIN** code.

Listening to music contents of a *Bluetooth* wireless technology device with your system

1 Press ADPT on the remote control to switch the receiver to ADAPTER PORT input.

- When the *Bluetooth* ADAPTER is not plugged into the **ADAPTER PORT**, **NO ADAPTER** will be displayed if **ADAPTER PORT** input is selected.

2 From the *Bluetooth* wireless technology device, perform the operation to connect to the *Bluetooth* ADAPTER.

3 Start playback of music contents stored on the *Bluetooth* wireless technology device.

This receiver's remote control buttons can be used for basic playback of files stored on *Bluetooth* wireless technology devices.

- Bluetooth* wireless technology device should be compatible with AVRCP profile.
- Depending on the *Bluetooth* wireless technology device you use, operation may differ from what is shown in the remote control buttons.



4 While listening to a source, set the remote control to the receiver operation mode, then press ADV SURR repeatedly to select SOUND RETRIEVER AIR.

The *Bluetooth*® word mark and logos are registered trademarks owned by Bluetooth SIG, Inc. and any use of such marks by PIONEER CORPORATION is under license. Other trademarks and trade names are those of their respective owners.

Listening to your system

Enjoying various types of playback using the listening modes

Using this receiver, you can listen to any source in surround sound. However, the options available will depend on your speaker setup and the type of source you're listening to.

To play with surround sound, check "Standard surround sound", "Using the Home THX modes" or "Using the Advanced surround effects" below and select the desired mode.

To play with the optimum mode for the input signal, see "Auto playback" or "Using Stream Direct". (The sound is played in stereo when 2-channel signals are input, in surround when multi-channel signals are input.)



Important

- The listening modes and many features described in this section may not be available depending on the current source, settings and status of the receiver.

Auto playback

There are many ways to listen back to sources using this receiver, but the simplest, most direct listening option is the Auto Surround feature. The receiver automatically detects what kind of source you're playing and selects multi-channel or stereo playback as necessary.

- Press **RECEIVER** to the receiver operation mode.

- While listening to a source, press **AUTO/ALC/DIRECT (AUTO SURR/ALC/STREAM DIRECT)** for auto playback of a source.

AUTO SURROUND shows briefly in the display before showing the decoding or playback format. Check the digital format indicators in the front panel display to see how the source is being processed.

- If the source is Dolby Digital, DTS, or Dolby Surround encoded, the proper decoding format will automatically be selected and shows in the display.
- When listening to the FM radio, the Neural Surround feature is selected automatically (see *Using Neural Surround* on page 33 for more on this).
- When listening to the **ADAPTER PORT** input, the **SOUND RETRIEVER AIR** feature is selected automatically.

ALC – In the Auto level control (ALC) mode, this receiver equalizes playback sound levels. Also, the low and high frequency sounds, dialogs, surround effects, etc., that are difficult to hear when the volume is low are adjusted to be optimal for the volume level. This mode is particularly optimum when listening at night.

OPTIMUM SURR – In the Optimum Surround mode, this receiver automatically optimizes sound balance in each scene based on actually set volume. The sound balancer controls three major theater sound elements dialogue, bass and surround with original algorithm.



Note

- When **ALC** is selected, the effect level can be adjusted using the **EFFECT** parameter in *Setting the Audio options* on page 50.

Standard surround sound

The following modes provide basic surround sound for stereo and multichannel sources.

- Press **RECEIVER** to the receiver operation mode.

- While listening to a source, press **STANDARD (STANDARD SURROUND)**.

If necessary, press repeatedly to select a listening mode.

- If the source is Dolby Digital, DTS, or Dolby Surround encoded, the proper decoding format will automatically be selected and shows in the display.
- If the surround back speakers are not connected, **Pro Logic IIx** becomes **Pro Logic II** (5.1 channel sound).

With two channel sources, you can select from:

- Pro Logic IIx MOVIE** – Up to 7.1 channel sound (surround back), especially suited to movie sources
- Pro Logic IIx MUSIC** – Up to 7.1 channel sound (surround back), especially suited to music sources
- Pro Logic IIx GAME** – Up to 7.1 channel sound (surround back), especially suited to video games
- PRO LOGIC** – 4.1 channel surround sound (sound from the surround speakers is mono)
- Pro Logic IIz HEIGHT** – Up to 7.1 channel sound (front height)
- WIDE SURROUND MOVIE** – Up to 7.1 channel sound (front wide), especially suited to movie sources
- WIDE SURROUND MUSIC** – Up to 7.1 channel sound (front wide), especially suited to music sources
- Neo:6 CINEMA** – 7.1 channel sound (surround back), especially suited to movie sources

- Neo:6 MUSIC** – 7.1 channel sound (surround back), especially suited to music sources
- Neural Surround** – Up to 7.1 channel sound (surround back), especially suited to music sources
- STEREO** – The audio is heard with your sound settings and you can still use the audio options.

With multichannel sources, if you have connected surround back, front height or front wide speakers, you can select (according to format):

- Pro Logic IIx MOVIE** – See above
- Pro Logic IIx MUSIC** – See above
- Dolby Digital EX** – Creates surround back channel sound for 5.1 channel sources and provides pure decoding for 6.1 channel sources (like Dolby Digital Surround EX)
- DTS-ES Matrix or DTS-ES Discrete** – Allows you to hear 6.1 channel playback with DTS-ES encoded sources
- DTS Neo:6** – Allows you to hear 6.1 channel playback with DTS encoded sources
- Neo:6** – Allows you to hear 6.1 channel playback
- Pro Logic IIz HEIGHT** – See above
- WIDE SURROUND MOVIE** – See above
- WIDE SURROUND MUSIC** – See above
- STEREO** – See above
- Straight Decode – Plays back without the effects above.



Note

- When listening sources in **Pro Logic IIz HEIGHT** mode, you can also adjust the **H.GAIN** effect (see *Setting the Audio options* on page 50).
- When listening to 2-channel sources in Dolby Pro Logic IIx Music mode, there are three further parameters you can adjust: **C.WIDTH**, **DIMENSION** and **PANORAMA**. See *Setting the Audio options* on page 50 to adjust them.

- When listening to 2-channel sources in Neo:6 Cinema or Neo:6 Music mode, you can also adjust the center image effect (see *Setting the Audio options* on page 50).
- **Neural Surround** can be selected for 2-channel signals for which the input signal is PCM (48 kHz or less), Dolby Digital, DTS or analog 2-channel sources.
- The stereo mode can also be selected by pressing the **STEREO** button.
- When listening through headphones, you can select **STEREO** mode only.

Using the Home THX modes

THX and Home THX are technical standards created by THX Ltd. for cinema and home theater sound. Home THX is designed to make home theater audio sound more like what you hear in a cinema.

Different THX options will be available depending on the source and the setting for surround back channel processing (see *THX Audio Setting* on page 71 for more on this).

1 Press **RECEIVER to the receiver operation mode.**

2 Press THX (HOME THX) to select a listening mode.

With two channel sources, press **THX** repeatedly to select a matrix-decoding process for the **THX CINEMA** mode (see *THX Audio Setting* on page 71 for an explanation of each process):

- **THX CINEMA**
- **THX MUSIC**
- **THX GAMES**
- **Pro Logic IIx MOVIE+THX CINEMA**
- **PRO LOGIC+THX CINEMA**
- **Neo:6 CINEMA+THX CINEMA**
- **Pro Logic IIx MUSIC+THX MUSIC**
- **Neo:6 MUSIC+THX MUSIC**
- **Pro Logic IIx GAME+THX GAMES**
- **PRO LOGIC IIz HEIGHT+THX CINEMA**
- **Pro Logic IIz HEIGHT+THX MUSIC**
- **Pro Logic IIz HEIGHT+THX GAMES**

With multichannel sources, press **THX (HOME THX)** repeatedly to select from:

- **THX CINEMA**
- **THX MUSIC**
- **THX GAMES**
- **THX Surround EX** – Allows you to hear 6.1 or 7.1 channel playback with 5.1 channel sources **MUSIC**
- **Neo:6 CINEMA+THX CINEMA**
- **Neo:6 MUSIC+THX MUSIC**
- **Neo:6 GAME+THX GAMES**
- **Pro Logic IIx MOVIE+THX CINEMA**
- **Pro Logic IIx GAME+THX MUSIC**
- **Pro Logic IIz HEIGHT+THX CINEMA**
- **Pro Logic IIz HEIGHT+THX MUSIC**
- **Pro Logic IIz HEIGHT+THX GAMES**



Note

- When listening sources in **Pro Logic IIz HEIGHT** mode, you can also adjust the **H.GAIN** effect (see *Setting the Audio options* on page 50).

Using the Advanced surround effects

The Advanced surround effects can be used for a variety of additional surround sound effects. Most Advanced Surround modes are designed to be used with film soundtracks, but some modes are also suited for music sources. Try different settings with various soundtracks to see which you like.

1 Press **RECEIVER to the receiver operation mode.**

2 Press ADV SURR (ADVANCED SURROUND) repeatedly to select a listening mode.

- **ACTION** – Designed for action movies with dynamic soundtracks
- **DRAMA** – Designed for movies with lots of dialog

- **SCI-FI** – Designed for science fiction with lots of special effects
- **MONO FILM** – Creates surround sound from mono soundtracks
- **ENT.SHOW** – Suitable for musical sources
- **EXPANDED** – Creates an extra wide stereo field
- **TV SURROUND** – Provides surround sound for both mono and stereo TV sources
- **ADVANCED GAME** – Suitable for video games
- **SPORTS** – Suitable for sports programs
- **CLASSICAL** – Gives a large concert hall-type sound
- **ROCK/POP** – Creates a live concert sound for rock and/or pop music
- **UNPLUGGED** – Suitable for acoustic music sources
- **EXT.STEREO** – Gives multichannel sound to a stereo source, using all of your speakers
- **F.S.SURR FOCUS** – Use to provide a rich surround sound effect directed to the center of where the front left and right speakers sound projection area converges.
- **F.S.SURR WIDE** – Use to provide a surround sound effect to a wider area than **FOCUS** mode.

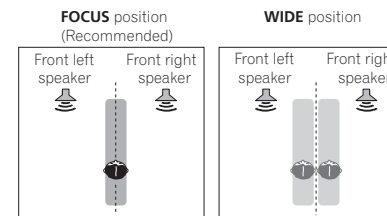

- **SOUND RETRIEVER AIR** – Suitable for listening to the sound from a *Bluetooth* wireless technology device. The **SOUND RETRIEVER AIR** listening mode can only be selected when the **ADAPTER PORT** input or listening through headphones.

- **PHONES SURR** – When listening through headphones, you can still get the effect of overall surround.



Note

- When an Advanced Surround listening mode is selected, the effect level can be adjusted using the **EFFECT** parameter in *Setting the Audio options* on page 50. However, with **F.S.SURR FOCUS**, **F.S.SURR WIDE** and **SOUND RETRIEVER AIR**, the effect level cannot be adjusted.
- The Front Stage Surround Advance (**F.S.SURR FOCUS** and **F.S.SURR WIDE**) function allows you to create natural surround sound effects using just the front speakers and the subwoofer.

Using Stream Direct

Use the Stream Direct modes when you want to hear the truest possible reproduction of a source. All unnecessary signal processing is bypassed, and you're left with the pure analog or digital sound source. Processing differs depending on the input signal and whether or not surround back speakers are connected. For details, see *Auto Surround, ALC and Stream Direct with different input signal formats* on page 90.

1 Press **RECEIVER to the receiver operation mode.**

2 While listening to a source, press AUTO/ALC/DIRECT (AUTO SURR/ALC/STREAM DIRECT) to select the mode you want.

Check the digital format indicators in the front panel display to see how the source is being processed.

- **AUTO SURROUND** – See *Auto playback* on page 37.
- **ALC** – Listening in Auto level control mode (page 37).

- **DIRECT** – Plays back sound from the source with the least modification next to **PURE DIRECT**. With **DIRECT**, the only modifications added to **PURE DIRECT** playback are calibration of the sound field by the MCACC system and the Phase Control effect.
- **PURE DIRECT** – Plays back unmodified sound from source with only minimal digital treatment. No sound is output from the Speaker B in this mode.
- **OPTIMUM SURR** – Listening in Optimum Surround mode (page 37).



Note

- When listening through headphones, you can select **ALC**, **OPTIMUM SURR** or **PURE DIRECT** mode only.

Selecting MCACC presets

- Default setting: **MEMORY 1**

If you have calibrated your system for different listening positions, you can switch between settings to suit the kind of source you're listening to and where you're sitting (for example, watching movies from a sofa, or playing a video game close to the TV).

1 Press **RECEIVER to the receiver operation mode.**

2 While listening to a source, press MCACC.

Press repeatedly to select one of the six MCACC presets. See *Data Management* on page 67 to check and manage your current settings.

- These settings have no effect when headphones are connected.
- You can also press **←/→** to select the MCACC preset.

Choosing the input signal

On this receiver, it is possible to switch the input signals for the different inputs as described below.

- This receiver can only play back Dolby Digital, PCM (32 kHz to 192 kHz) and DTS (including DTS 96/24) digital signal formats. The compatible signals via the HDMI terminals are: Dolby Digital, DTS, PCM (32 kHz to 192 kHz), Dolby TrueHD, Dolby Digital Plus, DTS-EXPRESS, DTS-HD Master Audio and SACD.
- You may get digital noise when an LD, CD, DVD or BD player compatible with DTS is playing an analog signal. To prevent noise, make the proper digital connections (page 16) and set the signal input to **DIGITAL**.
- Some DVD players don't output DTS signals. For more details, refer to the instruction manual supplied with your DVD player.

1 Press **RECEIVER to the receiver operation mode.**

2 Press **SIGNAL SEL to select the input signal corresponding to the source component.**

Each press cycles through the options as follows:

- **AUTO** – The receiver selects the first available signal in the following order: **HDMI; DIGITAL; ANALOG**.
- **ANALOG** – Selects an analog signal.
- **DIGITAL** – Selects an optical or coaxial digital signal.
- **HDMI** – Selects an HDMI signal.
 - When the **HDMI** audio output parameter is set to **THROUGH**, the sound will be heard through your TV, not from this receiver.

When set to **DIGITAL**, **HDMI** or **AUTO** (only selected **DIGITAL** or **HDMI**), the indicators light according to the signal being decoded (see *Display* on page 9).

Better sound using Phase Control

This receiver's Phase Control feature uses phase correction measures to make sure your sound source arrives at the listening position in phase, preventing unwanted distortion and/or coloring of the sound.

Phase Control technology provides coherent sound reproduction through the use of phase matching for an optimal sound image. The default setting is on and we recommend leaving Phase Control switched on for all sound sources.

1 Press **RECEIVER to the receiver operation mode.**

2 Press **PHASE CTRL (PHASE CONTROL) to switch on phase correction.**

The **PHASE CONTROL** indicator on the front panel lights.



Note

- Phase matching is a very important factor in achieving proper sound reproduction. If two waveforms are 'in phase', they crest and trough together, resulting in increased amplitude, clarity and presence of the sound signal. If a crest of a wave meets a trough, then the sound will be 'out of phase' and an unreliable sound image will be produced.
- The **PHASE CONTROL** feature is available even when the headphones are plugged in.
- If your subwoofer has a phase control switch, set it to the plus (+) sign (or 0°). However, the effect you can actually feel when **PHASE CONTROL** is set to **ON** on this receiver depends on the type of your subwoofer. Set your subwoofer to maximize the effect. It is also recommended you try changing the orientation or the place of your subwoofer.

- Set the built-in lowpass filter switch of your subwoofer to off. If this cannot be done on your subwoofer, set the cutoff frequency to a higher value.
- If the speaker distance is not properly set, you may not have a maximized **PHASE CONTROL** effect.
- The **PHASE CONTROL** mode cannot be set to **ON** in the following cases:
 - When the **PURE DIRECT** mode is switched on.
 - When the **HDMI** audio output parameter is set to **THROUGH** in Setting the *Setting the Audio options* on page 50.

Better sound using Phase Control and Full Band Phase Control

VSX-53 only

This receiver is equipped with the two types of functions that correct phase distortion and group delay: Phase Control and Full Band Phase Control. Activating Full Band Phase Control is strongly recommended because it also involves the effects of Phase Control. The Full Band Phase Control feature calibrates the frequency-phase characteristics of the speakers connected.

Standard speakers designed exclusively for audio use generally reproduce sound with the divided frequency bands output from a speaker system consisting of multiple speakers (in case of typical 3-way speakers, for instance, the tweeter, the squawker (midrange), and the woofer output sound in the high-, middle-, and low-frequency ranges, respectively). Though these speakers are designed to flatten the frequency-amplitude characteristics across wide ranges, there are cases where the group delay characteristics are not effectively flattened. This

phase distortion of the speakers subsequently causes group delay (the delay of low-frequency sound against high-frequency sound) during audio signal playback.

This receiver analyzes the frequency-phase characteristics of the speakers by measuring test signals output from the speakers with the supplied microphone, therefore flattening the analyzed frequency-phase characteristics during audio signal playback - the same correction is made for a pair of left and right speakers. This correction minimizes group delay between the ranges of a speaker and improves the frequency-phase characteristics across all ranges. Furthermore, the enhanced frequency-phase characteristics between channels ensure better surround sound integration for multichannel setting.

1 Press **RECEIVER to the receiver operation mode.**

2 Press **PHASE CTRL (PHASE CONTROL) to select **FULLBAND PHASE**.**

Both the Phase Control and Full Band Phase Control functions are switched on. The **FULL BAND** and  indicator, on the front panel lights.



Note

- To calibrate and analyze the frequency-phase characteristics of the speakers, either follow the **Full Auto MCACC** procedure under **Advanced MCACC** (see *Automatically conducting optimum sound tuning (Full Auto MCACC)* on page 26), or set **Auto MCACC** menu under **Auto MCACC** under **ADVANCED MCACC** to **Full Band Phase Ctrl**. Select **ALL** when you perform the **Auto MCACC** with **Auto MCACC** menu. Upon calibration of the frequency-phase characteristics of the speakers, the **Full Band Phase Ctrl** feature is automatically switched on.

- The original characteristics of group delay of the speakers calibrated and the targeted characteristics after correction can be displayed graphically in the GUI screen (see *Checking MCACC Data* on page 66). Also, by transferring the measurement data to the computer using the CD-ROM (AVNavigator), the original characteristics of group delay of the speakers calibrated and the corrected characteristics of group delay can be displayed in 3-dimension on your PC. For details, refer to the operating instructions for the Advanced MCACC PC Display Application Software included on the CD-ROM (AVNavigator).
- Depending on the input signal and listening mode, it may not be possible to set the **Full Band Phase Ctrl** mode to **ON**.
- The **Full Band Phase Ctrl** mode cannot be set to **ON** in the following cases:
 - When headphones are plugged in.
 - When the **PURE DIRECT** mode is switched on.
 - When the **HDMI** audio output parameter is set to **THROUGH** in Setting the *Setting the Audio options* on page 50.

Playback with HOME MEDIA GALLERY inputs

Enjoying the Home Media Gallery



This receiver's Home Media Gallery function allows you to listen to audio files or listen to Internet radio stations on a computer or other component connected to the receiver's LAN terminal. This chapter describes the setup and playback procedures required to enjoy these features. It is advisory that you also refer to the operation manual supplied with your network component.

- To listen to Internet radio stations, you must sign a contract with an ISP (Internet Service Provider) beforehand.
- Photo or video files cannot be played back.
- With Windows Media Player 11 or Windows Media Player 12, you can even play back copyrighted audio files on this receiver.

Features of Home Media Gallery

This receiver is equipped with the LAN terminal and you can enjoy the following features by connecting your components to these terminals.

- **Playback the music files stored in PCs**
You can playback a lot of musics stored in your PCs using this unit.
→ See *Playback with Home Media Gallery* on page 42 and *Playing back audio files stored on components on the network* on page 42.

- Besides a PC, you can also play back audio files stored on your other components with the built-in media server function based on DLNA 1.0 or DLNA 1.5 framework and protocols (i.e. network-capable hard disks and audio systems).

- **Listening to Internet radio stations**

You can select and listen to your favorite Internet radio station from the list of Internet radio stations created, edited, and managed by the vTuner database service exclusively for use with the Pioneer products.

→ See *Playback with Home Media Gallery* on page 42 and *Listening to Internet radio stations* on page 42.

- **Listening to Rhapsody, Sirius or Pandora**

→ See *Listening to Rhapsody* on page 43.

→ See *Listening to Sirius Internet Radio* on page 43.

→ See *Listening to Pandora Internet Radio* on page 43.

Introduction

About playable DLNA network devices

The Home Media Gallery allows you to play music on media servers connected on an identical Local Area Network (LAN) as the receiver. This unit allows for the playing of files stored on the following:

- PCs running Microsoft Windows Vista or XP with Windows Media Player 11 installed

- PCs running Microsoft Windows 7 with Windows Media Player 12 installed
- DLNA-compatible digital media servers (on PCs or other components)

Files stored in a PC or DMS (Digital Media Server) as described above can be played via command from an external Digital Media Controller (DMC). Devices controlled by this DMC to play files are called DMRs (Digital Media Renderers). This receiver supports this DMR function. When in the DMR mode, such operations as playing and stopping files can be performed from the external controller. Volume adjustment and the muting control are also possible. The DMR mode is canceled if the remote control unit is operated while in the DMR mode (aside from certain buttons, including the **MASTER VOLUME +/-**, **MUTE** and **DISP**).

- Depending on the external controller being used, playback may be interrupted when the volume is adjusted from the controller. In this case, adjust the volume from the receiver or remote control.

Using AirPlay on iPod touch, iPhone, iPad, and iTunes

This receiver supports AirPlay audio streaming from iPod touch (2nd, 3rd and 4th generations), iPhone 4, iPhone 3GS, iPad with iOS 4.2 or later, and iTunes 10.1 (Mac and PC) or later.

To use AirPlay, select your receiver on your iPod touch, iPhone, iPad or in iTunes. *1

The receiver's input will switch automatically to Home Media Gallery when AirPlay is in use. *2 The following operations can be performed when in AirPlay mode:

- Adjustment of the receiver's volume from iPod touch, iPhone, iPad or iTunes.
- Pause/resume, next/previous track, and shuffle/repeat from the remote control of the receiver.

- Display of the currently playing track information on the receiver's display, including artist, song and album name.

*1: For more information, see the Apple website (<http://www.apple.com>).

*2: The receiver's power automatically turns on when **Network Standby** at **Network Setup** is set to **ON**.

Note

- A network environment is required to use AirPlay.
- The receiver's name that shows up in the AirPlay UI on iPod touch, iPhone, iPad and iTunes can be changed by **Friendly Name** from **Network Setup**.
- AirPlay provided on this receiver has been developed and tested based on the software versions for the iPod, iPhone, iPad and the software versions for iTunes that are indicated on the Pioneer website. AirPlay may not be compatible with iPod, iPhone, iPad or iTunes software versions other than those indicated on the Pioneer website.

About the DHCP server function

To play back audio files stored on components on the network or listen to Internet radio stations, you must turn on the DHCP server function of your router. In case your router does not have the built-in DHCP server function, it is necessary to set up the network manually. Otherwise, you cannot play back audio files stored on components on the network or listen to Internet radio stations. See *Network Setup menu* on page 71 for more on this.

Authorizing this receiver

In order to be able to play with Home Media Gallery, this receiver must be authorized. This happens automatically when the receiver makes a connection over the network to the PC.

If not, please authorize this receiver manually on the PC. The authorization (or permission) method for access varies depending on the type of server currently being connected. For more information on authorizing this receiver, refer to the instruction manual of your server.

Playback with Home Media Gallery

Important

- When you play back audio files, 'Connecting...' is displayed before playback starts. The display may continue for several seconds depending on the type of file.
- In case a domain is configured in a Windows network environment, you cannot access a PC on the network while you are logged onto the domain. Instead of logging onto the domain, log onto the local machine.
- There are cases where the time elapsed may not be correctly displayed.

1 Press HMG to select Home Media Gallery as the input function.

It may take several seconds for this receiver to access the network. The following screen appears when the Home Media Gallery is selected as the input function. The number next to  indicates the number of connected servers.

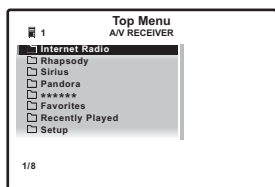

- The server without the  mark cannot be accessed.

2 Use ↑/↓ to select the category you want to play back, and then press ENTER.



Select a category from the following list:

- **Internet Radio** – Internet radio
- **Rhapsody** – Rhapsody music broadcast service
- **Sirius** – Internet radio that supports Sirius
- **Pandora** – Internet radio that supports Pandora
- **Server Name** – Server components on the network
- **Favorites** – Favorite songs currently being registered
- **Recently played** – Internet Radio listening history (most recent 20 incidents)

Depending on the selected category, the names of folders, files, and Internet radio stations are displayed.

3 Use ↑/↓ to select the folder, music files or Internet radio station to play back, and then press ENTER.

Press ↑/↓ to scroll up and down the list and select the desired item. When you press **ENTER**, playback starts with the playback screen being displayed for the selected item. To return to the list screen, press **RETURN**.

When the list screen is displayed from the playback screen, the playback screen reappears automatically if no operation is performed for 10 seconds while the list screen is displayed. Only audio files with the  mark can be played. In case of the folders with the  mark, use ↑/↓ and **ENTER** to select the desired folder and audio files.

4 Repeat step 3 to play back the desired song.

For detailed operating instructions, refer to the section shown below.

- Internet radio stations – See *Listening to Internet radio stations* on page 42 .
- Rhapsody – See *Listening to Rhapsody* on page 43 .

- Sirius – See *Listening to Sirius Internet Radio* on page 43 .
- Pandora – See *Listening to Pandora Internet Radio* on page 43 .
- Server – See *Playing back audio files stored on components on the network* on page 42 .

Playing back audio files stored on components on the network

You can perform the following operations with the remote control of this receiver. Note that some buttons are not available for operation depending on the category currently being played back.

- Press **HMG** to switch the remote control to the **HOME MEDIA GALLERY** operation mode.

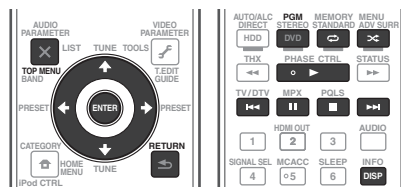

Listening to Internet radio stations

Internet radio is an audio broadcasting service transmitted via the Internet. There are a large number of Internet radio stations broadcasting a variety of services from every corner of the world. Some are hosted, managed, and broadcast by private individuals while others are by the corresponding traditional terrestrial radio stations or radio networks. Whereas terrestrial, or OTA (over-the-air), radio stations are geographically restricted on the range of radio waves broadcast from a transmitter through the air, Internet radio stations are accessible from anywhere in the world, as long as there is a connection to the Internet, as services are not transmitted through the air but are delivered

over the World Wide Web. On this receiver you can select Internet radio stations by genre as well as by region. Depending on the Internet line conditions, the sound may not be smooth when playing Internet radio.

About list of Internet radio

The list of Internet radio stations on this receiver is created, edited, and managed by the vTuner database service exclusively for use with this receiver. For details about vTuner, see *vTuner* on page 92 .

Saving and retrieving Internet radio stations

You can easily save and retrieve saved Internet radio stations. See *Advanced operations for Internet radio* on page 43 for more on this.

- To listen to Internet radio stations, you must have high-speed broadband Internet access. With a 56 K or ISDN modem, you may not enjoy the full benefits of Internet radio.
- The port number varies depending on the Internet radio station. Check the firewall settings.
- A list of Internet radio stations provided by the vTuner database service is subject to change or deletion without notice due to various reasons.
- Broadcasts may be stopped or interrupted depending on the Internet radio station. In this case, you cannot listen to a radio station selected from the list of Internet radio stations.

Registering broadcast stations not on the vTuner list from the special Pioneer site

With the receiver, broadcast stations not included on the list of station distributed by vTuner can be registered and played. Check the access code required for registration on the receiver, use this access code to access the

special Pioneer Internet radio site and register the desired broadcast stations in your favorites. The address of the special Pioneer Internet radio site is:

<http://www.radio-pioneer.com>

1 Display the Internet Radio list screen.

To display the Internet Radio list screen, perform steps 1 to 3 at *Playback with Home Media Gallery* on page 42.

2 Use **↑/↓** to select 'Help', then press ENTER.

3 Use **↑/↓** to select 'Get access code', then press ENTER.

The access code required for registration on the special Pioneer Internet radio site is displayed. Make a memo of this address.

The following can be checked on the **Help** screen:

- **Get access code** – The access code required for registration on the special Pioneer Internet radio site is displayed.
- **Show Your WebID/PW** – After registering on the special Pioneer Internet radio site, the registered ID and password are displayed.
- **Reset Your WebID/PW** – Resets all the information registered on the special Pioneer Internet radio site. When reset, all the registered broadcast stations are also cleared. If you want to listen to the same stations, re-register after resetting.

4 Access the special Pioneer Internet radio site from your computer and perform the registration process.

<http://www.radio-pioneer.com>

Access the above site and use the access code in step 3 to perform user registration, following the instructions on the screen.

5 Register the desired broadcast stations as your favorites, following the instructions on the computer's screen.

Both broadcast stations not on the vTuner list and stations on the vTuner list can be

registered. In this case they are registered on the receiver as favorite broadcast stations and can be played.

Listening to Rhapsody

Rhapsody is a paid digital music broadcast service provided by RealNetworks. Rhapsody offers 30-day free trial. Access the website in order to set up a trial account: <http://www.rhapsody.com/pioneer/signup>

- You must have a registered account in order to listen to songs using Rhapsody. For details, see *Checking about the Accounts* on page 43.
- As of April 2011, the Rhapsody service is only offered in the United States.
- Some functions may be changed at Rhapsody's discretion.

Listening to Sirius Internet Radio

Check the website below to listen to Sirius Internet Radio: <http://www.sirius.com/siriusinternetradio>

- You must have a registered account in order to listen to songs using Sirius Internet Radio. For details, see *Checking about the Accounts* on page 43.
- Some functions may be changed at Sirius's discretion.

Listening to Pandora Internet Radio

Pandora is personalized internet radio that is designed to help you discover new music you'll love mixed in with music you already know. For details, check the website: <http://www.pandora.com>

- You must have a registered account in order to listen to songs using Pandora Internet Radio. Select **Pandora**, then follow the instructions on the screen to make the account settings. Also see *Checking about the Accounts* on page 43.

- As of April 2011, the Pandora service is only offered in the United States.
- Some functions may be changed at Pandora's discretion.

Playing back your favorite songs

You can register up to 20 of your favorite songs or Internet radio stations in the Favorites folder. Note that only the audio files stored on components on the network can be registered.

Registering and deleting audio files and Internet radio stations in and from the Favorites folder

Press **PGM** while a song is being played back or stopped. The selected song is then registered in the Favorites folder.

Up to 20 songs or Internet radio stations can be registered.

To delete a registered song, select the Favorites folder, select the song you want to delete from the folder, and press **CLR**. The selected song is then deleted from the Favorites folder.

Advanced operations for Internet radio

Saving Internet radio stations

This receiver can remember the Internet radio stations that you often listen to in seven classes (**A** to **G**) with up to nine stations in each class to make the total of 63 stations at its maximum capacity.

1 Tune into the Internet radio station that you want to save.

Tune into the desired Internet radio station by following Steps 1 to 3 on page 42.

2 Press **T.EDIT** to switch to the station-saving mode.

3 Press **CLASS** to select the class that you want to save the station in.

Select the desired class from **A** to **G**.

4 Use **↑/↓** to select the number that you want to save the station as, and then press ENTER.

You can also select the station number by using the number buttons. Select the desired number from 1 to 9.

Retrieving saved Internet radio stations

You need to save Internet radio stations first before retrieving them. If there are no Internet radio stations currently being saved, see *Saving Internet radio stations* on page 43 and save at least one Internet radio station before proceeding with the following steps.

1 Select the class that you want to retrieve an Internet radio station from.

Each time you press **CLASS**, the class switches to **A** to **G** in turn.

2 Use **↑/↓** to select the station number that you want to retrieve.

You can also select the station number by using the number buttons.

'**Preset Not Stored**' appears when you select an Internet radio station currently not being saved.

Checking about the Accounts

Screen concerning Rhapsody, Sirius or Pandora Internet Radio account registration.

1 Press **HMG** to select Home Media Gallery as the input function.

2 Select 'Setup' then press ENTER.

3 Select 'Accounts' and press ENTER to confirm your selection.

4 Select Rhapsody, Sirius or Pandora and press ENTER.

The contents below can be checked when Rhapsody is selected.

- Set Account
- Account Info

The contents below can be checked when Sirius is selected.

- Set Account

The contents below can be checked when Pandora is selected.

- Set Account
- Sign out

5 Follow the instructions on the screen to input and set.



Note

- When disposing of the product, we recommend you reset it to delete the data. See *Resetting the system* on page 55.

About network playback

The network playback function of this unit uses the following technologies:

Windows Media Player

See *Windows Media Player 11/Windows Media Player 12* on page 92 for more on this.

Windows Media DRM

Microsoft Windows Media Digital Rights Management (WMDRM) is a platform to protect and securely deliver content for playback on computers, portable devices and network devices. Home Media Gallery functions as a WMDRM 10 for networked devices. WMDRM protected content can only be played on media servers supporting WMDRM.

Content owners use WMDRM technology to protect their intellectual property, including copyrights. This device uses WMDRM software to access WMDRM protected content. If the WMDRM software fails to protect the content, content owners may ask Microsoft to revoke the software's ability to use WMDRM to play or copy protected content. Revocation does not affect unprotected content. When you download licenses for protected content, you agree that Microsoft may include a revocation list with the licenses. Content owners may require you to upgrade WMDRM to access their content. If you decline an upgrade, you will not be able to access content that requires the upgrade.

This product is protected by certain intellectual property rights of Microsoft. Use or distribution of such technology outside of this product is prohibited without a license from Microsoft.

DLNA



DLNA CERTIFIED™ Audio Player

The Digital Living Network Alliance (DLNA) is a cross-industry organization of consumer electronics, computing industry and mobile device companies. Digital Living provides consumers with easy sharing of digital media through a wired or wireless network in the home. The DLNA certification logo makes it easy to find products that comply with the DLNA Interoperability Guidelines. This unit complies with DLNA Interoperability Guidelines v1.5. When a PC running DLNA server software or other DLNA compatible device is connected to this player, some setting changes of software or other devices may be required. Please refer

to the operating instructions for the software or device for more information.

DLNA™, the DLNA Logo and DLNA CERTIFIED™ are trademarks, service marks, or certification marks of the Digital Living Network Alliance.

Content playable over a network

- Even when encoded in a compatible format, some files may not play correctly.
- Movie or Photo files cannot be played back.
- There are cases where you cannot listen to an Internet radio station even if the station can be selected from a list of radio stations.
- Some functions may not be supported depending on the server type or version used.
- Supported file formats vary by server. As such, files not supported by your server are not displayed on this unit. For more information check with the manufacturer of your server.

Disclaimer for Third Party Content

ACCESS TO THIRD PARTY CONTENT SERVICES, INCLUDING ALL ASSOCIATED FEATURES AND FUNCTIONALITIES, IS PROVIDED "AS IS," "AS AVAILABLE" AND AT THE USER'S OWN RISK, WITHOUT WARRANTY OF ANY KIND. PIONEER DISCLAIMS ALL WARRANTIES, EXPRESS OR IMPLIED, IN CONNECTION WITH ACCESS TO AND USE OF CONTENT SERVICES THROUGH THIS DEVICE, INCLUDING WITHOUT LIMITATION WARRANTIES OF MERCHANTABILITY, SATISFACTORY QUALITY, FITNESS FOR A PARTICULAR PURPOSE, AND NON-INFRINGEMENT. PIONEER DOES NOT GUARANTEE, REPRESENT, OR WARRANT THAT CONTENT SERVICES WILL BE FREE FROM ERRORS, INTERRUPTION,

LOSS, CORRUPTION, ATTACK, VIRUSES, INTERFERENCE, HACKING, OR OTHER SECURITY INTRUSION, AND PIONEER DISCLAIMS ANY LIABILITY IN CONNECTION WITH THE FOREGOING. PIONEER IS NOT LIABLE OR RESPONSIBLE FOR ANY LOSS OR DAMAGE ARISING FROM ACCESS TO OR USE OF CONTENT. NO ORAL OR WRITTEN INFORMATION OR ADVICE GIVEN BY PIONEER OR ITS CUSTOMER SERVICES REPRESENTATIVES WILL CREATE ANY SUCH WARRANTY. IN NO EVENT WILL PIONEER, ITS AFFILIATES, OR THEIR RESPECTIVE OFFICERS, DIRECTORS, OR EMPLOYEES BE LIABLE IN CONNECTION WITH YOUR USE OF THIRD PARTY CONTENT SERVICES THROUGH THIS DEVICE FOR PERSONAL INJURY OR SPECIAL, INCIDENTAL, INDIRECT OR CONSEQUENTIAL DAMAGES OF ANY KIND, INCLUDING WITHOUT LIMITATION DAMAGES FOR ATTORNEY'S FEES, LOST DATA OR LOST PROFITS, REGARDLESS OF THE THEORY OF LIABILITY AND WHETHER OR NOT ADVISED OF THE POSSIBILITY OF SUCH DAMAGES. IN NO EVENT WILL PIONEER'S TOTAL LIABILITY TO YOU FOR ALL DAMAGES ARISING FROM THE USE OR INABILITY TO USE THIRD PARTY CONTENT SERVICES (OTHER THAN AS MAY BE REQUIRED BY LAW IN CASES INVOLVING PERSONAL INJURY) EXCEED \$10.00. THE FOREGOING LIMITATIONS WILL APPLY EVEN IF THE ABOVE REMEDY FAILS OF ITS ESSENTIAL PURPOSE. IF ANY APPLICABLE AUTHORITY HOLDS ANY PORTION OF THIS SECTION TO BE UNENFORCEABLE, THEN LIABILITY WILL BE LIMITED TO THE MAXIMUM EXTENT PERMITTED BY APPLICABLE LAW.

About playback behavior over a network

- Playback may stall when the PC is switched off or any media files stored on it are deleted while playing content.
- If there are problems within the network environment (heavy network traffic, etc.) content may not be displayed or played properly (playback may be interrupted or stalled). For best performance, a 100BASE-TX connection between player and PC is recommended.
- If several clients are playing simultaneously, as the case may be, playback is interrupted or stalled.
- Depending on the security software installed on a connected PC and the setting of such software, network connection may be blocked.

Pioneer is not responsible for any malfunction of the player and/or the Home Media Gallery features due to communication error/malfunctions associated with your network connection and/or your PC, or other connected equipment. Please contact your PC manufacturer or Internet service provider.

"Windows Media™" is a trademark of Microsoft Corporation.

This product includes technology owned by Microsoft Corporation and cannot be used or distributed without a license from Microsoft Licensing, Inc.

Microsoft®, Windows®7, Windows®Vista, Windows®XP, Windows®2000, Windows®Millennium Edition, Windows®98, and WindowsNT® are either registered trademarks or trademarks of Microsoft Corporation in the United States and/or other countries.

About playable file formats

The Home Media Gallery feature of this receiver supports the following file formats. Note that some file formats are not available for playback although they are listed as playable file formats. Also, the compatibility of file formats varies depending on the type of server. Check with your server to ensure the compatibility of file formats supported by your server.

- Internet radio playback may be affected by the Internet communications environment, and in this case playback may not be possible even with the file formats listed here.

Music files

Category	Extension	Stream				
MP3 <a>	.mp3	MPEG-1 Audio Layer-3	Sampling frequency	8 kHz to 48 kHz		
			Quantization bitrate	16 bit		
			Channel	2 ch		
			Bitrate	8 kbps to 320 kbps		
			VBR/CBR	Supported/Supported		
LPCM	— 	LPCM	Sampling frequency	8 kHz to 48 kHz		
			Quantization bitrate	16 bit, 20 bit, 24 bit		
			Channel	2 ch		
WAV	.wav	LPCM	Sampling frequency	8 kHz to 192 kHz		
			Quantization bitrate	16 bit, 20 bit, 24 bit		
			Channel	2 ch		
WMA	.wma	WMA2/7/8	Sampling frequency	8 kHz to 48 kHz		
			Quantization bitrate	16 bit		
			Channel	2 ch		
			Bitrate	5 kbps to 320 kbps		
		VBR/CBR	Supported/Supported			
		WMA9			Sampling frequency	8 kHz to 48 kHz
					Quantization bitrate	16 bit
Channel	2 ch					
AAC	.m4a .aac .3gp .3g2	MPEG-4 AAC LC MPEG-4 HE AAC (aacPlus v1/2)	Sampling frequency	32 kHz to 48 kHz		
			Quantization bitrate	16 bit		
			Channel	2 ch		
			Bitrate	16 kbps to 320 kbps		
			VBR/CBR	Supported/Supported		

Category	Extension	Stream		
FLAC	.flac	FLAC	Sampling frequency	8 kHz to 192 kHz
			Quantization bitrate	8 bit, 16 bit, 24 bit
			Channel	2 ch
			Bitrate	—
			VBR/CBR	—

a *"MPEG Layer-3 audio decoding technology licensed from Fraunhofer IIS and Thomson multimedia."*

b Only streaming data from servers is concerned, so there is no extension.

Control with HDMI function

About the Control with HDMI function

Synchronized operations below with a **Control** with HDMI-compatible Pioneer TV or Blu-ray Disc player or with a component of another make that supports the **Control** with HDMI functions are possible when the component is connected to the receiver using an HDMI cable.

- The receiver's volume can be set and the sound can be muted using the TV's remote control.
- The receiver's input switches over automatically when the TV's input is changed or a **Control** with HDMI-compatible component is played.
- The receiver's power is also set to standby, when the TV's power is set to standby.



Important

- With Pioneer devices, the **Control** with HDMI functions are referred to as "KURO LINK".
- You cannot use this function with components that do not support **Control** with HDMI.
- We only guarantee this receiver will work with Pioneer **Control** with HDMI-compatible components and components of other makes that support the **Control** with HDMI function. However, we do not guarantee that all synchronized operations will work with components of other makes that support the **Control** with HDMI function.
- Use a High Speed HDMI® cable when you want to use the **Control** with HDMI function. The **Control** with HDMI function may not work properly if a different type of HDMI cable is used.

- For details about concrete operations, settings, etc., refer to also the operating instructions for each component.

Making Control with HDMI connections

You can use synchronized operation for a connected TV and up to 7 other components.

- Be sure to connect the TV's audio cable to the audio input of this unit. When the TV and receiver are connected by HDMI connections, if the TV supports the HDMI ARC (Audio Return Channel) function, the sound of the TV is input to the receiver via the **HDMI OUT** terminal, so there is no need to connect an audio cable. In this case, set **TV Audio at HDMI Setup to via HDMI** (see *HDMI Setup* on page 47).

For details, see *Connecting your TV and playback components* on page 17.



Important

- When connecting this system or changing connections, be sure to switch the power off and disconnect the power cord from the wall socket. After completing all connections, connect the power cords to the wall socket.
- After this receiver is connected to an AC outlet, a 2 second to 10 second HDMI initialization process begins. You cannot carry out any operations during this process. The **HDMI** indicator in the front panel display blinks during this process, and you can turn on this receiver once it has stopped blinking. When you set the **Control** with HDMI to **OFF**, you can skip this process. For details about the **Control** with HDMI feature, see *Control with HDMI function* on page 47.

- To get the most out of this function, we recommend that you connect your HDMI component not to a TV but rather directly to the HDMI terminal on this receiver.
- *VSX-53 only:*
The **Control** with HDMI function can be used with a TV connected to the **HDMI OUT 1** terminal, but not with a TV connected to the **HDMI OUT 2** terminal.

HDMI Setup

You must adjust the settings of this receiver as well as the connected **Control** with HDMI-compatible components in order to make use of the **Control** with HDMI function. For more information see the operating instructions for each component.

- 1 Press **RECEIVER** on the remote control, then press **HOME MENU**.
- 2 Select '**System Setup**', then press **ENTER**.
- 3 Select '**HDMI Setup**', then press **ENTER**.
- 4 Select the '**Control**' setting you want. Choose whether to set this unit's **Control** with HDMI function **ON** or **OFF**. You will need to set it to **ON** to use the **Control** with HDMI function. When using a component that does not support the **Control** with HDMI function, set this to **OFF**.

- **ON** – Enables the **Control** with HDMI function. When this unit's power is turned off and you have a supported source begin playback while using the **Control** with HDMI function, the audio and video outputs from the HDMI connection are output from the TV.
- **OFF** – The **Control** with HDMI is disabled. Synchronized operations cannot be used. When this unit's power is turned off, audio and video of sources connected via HDMI are not output.

5 Select the 'Control Mode' setting you want.

Choose whether you want to enable HDMI for all linked functions or the PQLS function only. However, Display Power Off will activate the settings set forth in step 6 below.

- **ALL** – Enabled for all linked functions.
- **PQLS** – Enabled only for the PQLS function. When **PQLS** is selected, link functions other than the PQLS function may not work properly. If you wish to use all link functions, select **ALL**.

6 Select the 'Display Power Off' setting you want.

If the TV's power is turned off while using the **Control** with HDMI function, the receiver's power is also turned off (all power off function). This function can be disabled.

- **YES** – The all power off function is enabled. The receiver's power turns off together with the TV's power. This function only works when the input for a component connected to the receiver by HDMI connection is selected or when watching the TV.
- **NO** – The all power off function is disabled. The receiver's power is not affected when the TV's power is turned off.

7 Select the 'Standby Through' setting you want.

When **Control** is **ON**, the signals of the input device or TV connected to the receiver can be transferred even when the receiver's power is in the standby mode (Standby Through mode). The power consumption in this Standby Through mode can be set to conserve energy.

- **Normal** – Regular mode. Power-up time from the Standby Through mode is short.
- **Eco** – Power consumption in the Standby Through mode is reduced. Some time is required for powering up from the Standby Through mode.

8 Select the 'TV Audio' setting you want.

When a TV supporting the HDMI ARC (Audio Return Channel) function is connected to the receiver, the sound of the TV can be input via the **HDMI OUT** terminal.

- **Normal** – The TV's sound is input from the Audio input terminals other than HDMI inputs.
- **via HDMI** – The TV's sound is input via the HDMI terminal. This can only be selected when **Control** is set to **ON**.

9 Select the '12V Trigger' setting you want.

V SX-53 only:

The component connected to the **12 V TRIGGER** jack can be turned on and off when **HDMI OUT** is switched. **HDMI OUT 1**, **HDMI OUT 2** or **OFF** can be selected. Select **OFF** when you want the component to switch when the input function is switched.

10 When you're finished, press HOME MENU.

Before using synchronization

Once you have finished all connections and settings, you must:

- 1 Put all components into standby mode.
- 2 Turn the power on for all components, with the power for the TV being turned on last.
- 3 Choose the HDMI input to which the TV is connected to this receiver, and see if video output from connected components displays properly on the screen or not.
- 4 Check whether the components connected to all HDMI inputs are properly displayed.

About synchronized operations

The **Control** with HDMI-compatible component connected to the receiver operates in sync as described below.

- From the menu screen of the **Control** with HDMI-compatible TV, set audio to be played through this receiver, and the receiver will switch to the synchronized amp mode.
- When in the synchronized amp mode, you can adjust the receiver's volume or mute the sound using the TV's remote control.
- When in the synchronized amp mode, the synchronized amp mode is canceled when the receiver's power is turned off. To turn the synchronized amp mode back on, set audio to be played through the receiver from the TV's menu screen, etc. This receiver will power up and switch to the synchronized amp mode.
- When the synchronized amp mode is canceled, the receiver's power turns off if you were viewing an HDMI input or a TV program on the TV.
- When in the synchronized amp mode, the synchronized amp mode is canceled if an operation that produces sound from the TV is performed from the TV's menu screen, etc.
- When the TV's power is set to standby, the receiver's power is also set to standby. (Only when the input for a component connected to the receiver by HDMI connection is selected or when watching the TV.)
- The receiver's input switches automatically when the **Control** with HDMI-compatible component is played.
- The receiver's input switches automatically when the TV's input is switched.
- The synchronized amp mode remains in effect even if the receiver's input is switched to a component other than one connected by HDMI.

The operations below can also be used on Pioneer **Control** with HDMI-compatible TVs.

- When the receiver's volume is adjusted or the sound is muted, the volume status is displayed on the TV's screen.
- When the OSD language is switched on the TV, the receiver's language setting also switches accordingly.

About connections with a product of a different brand that supports the Control with HDMI function

The synchronized operations below can be used when the receiver's **Control** with HDMI function is connected to a TV of a brand other than Pioneer that supports the **Control** with HDMI function. (Depending on the TV, however, some of the **Control** with HDMI functions may not work.)

- When the TV's power is set to standby, the receiver's power is also set to standby. (Only when the input for a component connected to the receiver by HDMI connection is selected or when watching the TV)
- The sound of TV programs or an external input connected to the TV can also be output from the speakers connected to the receiver. (If the TV does not support the HDMI ARC (Audio Return Channel) function, this requires connection of an optical digital cable, etc., in addition to the HDMI cable.)

The synchronized operations below can be used when the receiver's **Control** with HDMI function is connected to a player or recorder of a brand other than Pioneer that supports the **Control** with HDMI function.

- When playback starts on the player or recorder, the receiver's input switches to the HDMI input to which that component is connected.

See the Pioneer website for the latest information on the models of non-Pioneer brands and products that support the **Control** with HDMI function.

Setting the PQLS function

PQLS (Precision Quartz Lock System) is a digital audio signal transfer control technology using the **Control** with HDMI function. It offers higher-quality audio playback by controlling audio signals from the receiver to a PQLS compatible player, etc. This enables removing jitter that has a negative effect on the quality of the sound and is generated upon transmission.

- On players compatible with PQLS Bit-stream, PQLS always works for all sources.
- On players compatible with PQLS Multi Surround, PQLS works for all sources. Set the player's audio output to Linear PCM.
- On players compatible with PQLS 2 ch Audio, PQLS only works when playing CDs.

Please refer to the operating instructions supplied with your player for more information. This function is activated when **Control** is set to **ON**.

- If a listening mode other than **AUTO SURROUND**, **ALC**, **DIRECT**, **PURE DIRECT**, **OPTIMUM SURR** or **STEREO** is selected while the PQLS effect is enabled, the PQLS effect is disabled.
- When this receiver is connected by HDMI cable to a Pioneer player that is compatible with the PQLS function via HDMI connection and HDMI reauthentication is performed (the **HDMI** indicator blinks), the PQLS effect is enabled and the listening mode is set to **AUTO SURROUND** if a listening mode other than **AUTO SURROUND**, **ALC**, **DIRECT**, **PURE DIRECT**, **OPTIMUM SURR** or **STEREO** is selected.

- Press **RECEIVER** on the remote control, then press **PQLS** to select the **PQLS** setting.

The setting is displayed on the front panel display.

- **PQLS AUTO** – PQLS is enabled. A precision quartz controller in this receiver eliminates distortion caused by timing errors (jitter), giving you the best possible digital-to-analog conversion when you use the HDMI interface. This is valid as an HDMI function for PQLS-compatible players.
- **PQLS OFF** – PQLS is disabled.

Cautions on the Control with HDMI function

- Connect the TV directly to this receiver. Interrupting a direct connection with other amps or an AV converter (such as an HDMI switch) can cause operational errors.
- Only connect components (Blu-ray Disc player, etc.) you intend to use as a source to the HDMI input of this receiver. Interrupting a direct connection with other amps or an AV converter (such as an HDMI switch) can cause operational errors.
- When **Control** is set to **ON**, **HDMI Input** in *The Input Setup menu* on page 28 is automatically set to **OFF**.
- When the receiver's **Control** is turned **ON**, even if the receiver's power is in the standby mode, it is possible to output the audio and video signals from a player via HDMI to the TV without producing sound from the receiver, but only when a **Control** with HDMI-compatible component (Blu-ray Disc player, etc.) and compatible TV are connected. In this case, the receiver's power turns on and the power and **HDMI** indicators light.

Setting	What it does	Option(s)
LFE (LFE Attenuate)	Some audio sources include ultra-low bass tones. Set the LFE attenuator as necessary to prevent the ultra-low bass tones from distorting the sound from the speakers. The LFE is not limited when set to 0 dB, which is the recommended value. When set to -5 dB, -10 dB, -15 dB or -20 dB, the LFE is limited by the respective degree. When OFF is selected, no sound is output from the LFE channel.	◀ OFF/ -20dB/ -15dB/ -10dB/ -5dB/ 0dB ▶ Default: 0dB
SACD GAIN <e>	Brings out detail in SACDs by maximizing the dynamic range (during digital processing).	0dB +6dB
HDMI (HDMI Audio) <f>	Specifies the routing of the HDMI audio signal out of this receiver (amp) or through to a TV. When THROUGH is selected, no sound is output from this receiver.	AMP THROUGH
A.DELAY (Auto delay) <g>	This feature automatically corrects the audio-to-video delay between components connected with an HDMI cable. The audio delay time is set depending on the operational status of the display connected with an HDMI cable. The video delay time is automatically adjusted according to the audio delay time.	OFF ON
C.WIDTH (Center Width) (Applicable only when using a center speaker) <h>	Provides a better blend of the front speakers by spreading the center channel between the front right and left speakers, making it sound wider (higher settings) or narrower (lower settings).	◀ 0 to 7 ▶ Default: 3
DIMENSION <h>	Adjusts the depth of the surround sound balance from front to back, making the sound more distant (minus settings), or more forward (positive settings).	◀ -3 to +3 ▶ Default: 0
PANORAMA <h>	Extends the front stereo image to include the surround speakers for a 'wraparound' effect.	OFF ON
C.IMAGE (Center Image) (Applicable only when using a center speaker) <i>	Adjusts the center image to create a wider stereo effect with vocals. Adjust the effect from 0 (all center channel sent to front right and left speakers) to 10 (center channel sent to the center speaker only).	◀ 0 to 10 ▶ Defaults: Neo:6 MUSIC: 3 Neo:6 CINEMA: 10
EFFECT	Sets the effect level for the currently selected Advanced Surround or ALC mode (each mode can be set separately).	◀ 10 to 90 ▶ Defaults: EXT.STEREO: 90 Others: 50
H.GAIN (Height Gain)	Adjusts the output from the front height speaker when listening in Pro Logic IIz HEIGHT mode. If set to HIGH, the sound from the top will be more emphasized.	LOW MID HIGH

Setting	What it does	Option(s)
V.SB (Virtual Surround Back) <j>	When you're not using surround back speakers, selecting this mode allows you to hear a virtual surround back channel through your surround speakers. You can choose to listen to sources with no surround back channel information.	OFF ON
V.HEIGHT (Virtual Height) <k>	When you're not using front height speakers, selecting this mode allows you to hear a virtual front height channel through your front speakers.	OFF ON
V.DEPTH (Virtual Depth) <l>	When this mode is selected, the sound field expands virtually to behind the display, resulting in a sound field with the same depth as the 3D picture to achieve a better sense of presence.	OFF MIN MID MAX

- The adjustment can be made only when **TONE** is set to **ON**.
- With the **iPod/USB**, **HOME MEDIA GALLERY** or **ADAPTER PORT** input function, by default **S.RTRV** is set to **ON**.
- UP1 to UP4 can be selected only when the front height speaker is connected. The presence or absence of effects depends on the listening mode.
- The initially set **AUTO** is only available for Dolby TrueHD signals. Select **MAX** or **MID** for signals other than Dolby TrueHD.
- You shouldn't have any problems using this with most SACD discs, but if the sound distorts, it is best to switch the gain setting back to **0dB**.
- The HDMI Audio setting cannot be switched while performing synchronized amp mode operations.
 - The synchronized amp mode must be turned on in order to play the receiver's HDMI audio and video input signals from the TV with the receiver's power in the standby mode. See *About synchronized operations* on page 48.
- This feature is only available when the connected display supports the automatic audio/video synchronizing capability ('lipsync') for HDMI. If you find the automatically set delay time unsuitable, set **A.DELAY** to **OFF** and adjust the delay time manually. For more details about the lipsync feature of your display, contact the manufacturer directly.
- Only when listening to 2-channel sources in Dolby Pro Logic IIx Music/Dolby Pro Logic II Music mode.
 - Only when listening to 2-channel sources in Neo:6 MUSIC/CINEMA mode.
 - You can't use the Virtual Surround Back mode when the headphones are connected to this receiver or when any of the stereo, Front Stage Surround Advance, Sound Retriever Air or Stream Direct modes is selected.
 - You can only use the Virtual Surround Back mode if the surround speakers are on and the **SB** setting is set to **NO** or if **Front Bi-Amp** or **ZONE 2** is selected at **Speaker System**. It can also be used when **Speaker B** is selected at **Speaker System** and **SP:▶A+B ON** is selected with the **SPEAKERS** button.
 - You can't use the Virtual Height mode when the headphones are connected to this receiver or when any of the stereo, Front Stage Surround Advance, Sound Retriever Air or Stream Direct modes is selected.
 - You can only use the Virtual Height mode if the surround speakers are on and the **FH** setting is set to **NO**. It can also not be used when playing signals containing actual front height channel information.
 - This mode is effective for contents with a sampling frequency of 48 kHz or less.
 - You can't use the Virtual Depth mode when the headphones are connected to this receiver or when any of the stereo, Front Stage Surround Advance, Sound Retriever Air or Stream Direct modes is selected.
 - You can only use the Virtual Depth mode if the surround speakers are on.

Setting the Video options

There are a number of additional picture settings you can make using the **VIDEO PARAMETER** menu. The defaults, if not stated, are listed in bold.



Important

- Note that if an option cannot be selected on the **VIDEO PARAMETER** menu, it is unavailable due to the current source, setting and status of the receiver.
- All of the setting items can be set for each input function.
- Setting items other than **V.CONV** can only be selected when **V.CONV** is set to **ON**.

1 Press **RECEIVER to the receiver operation mode, then press **VIDEO PARAMETER**.**

2 Use **↑/↓ to select the setting you want to adjust.**

Depending on the current status/mode of the receiver, certain options may not be able to be selected. Check the table below for notes on this.

3 Use **←/→ to set as necessary.**

See the table below for the options available for each setting.

4 Press **RETURN to confirm and exit the menu.**

Video parameter menu

Setting	What it does	Option(s)
V.CONV (Digital Video Converter) <a>	Converts video signals for output from the MONITOR OUT jacks (including HDMI OUT connector) for all video types (see page 16).	ON OFF
RES (Resolution) 	Specifies the output resolution of the video signal (when video input signals are output at the HDMI OUT connector, select this according to the resolution of your monitor and the images you wish to watch). ("480p" indicates the 480p/576p resolution setting.)	AUTO PURE 480p 720p 1080i 1080p 1080/24p
PCINEMA (PureCinema) <c, e>	This setting optimizes the operation of the progressive scanning circuit for playing film materials. Normally set it to AUTO . If the picture seems unnatural, switch this to ON or OFF .	AUTO ON OFF
P.MOTION (Progressive Motion) <c, e>	Adjusts the motion and still picture quality when video output is set to progressive.	◀ -4 to +4 ▶ Default: 0

Setting	What it does	Option(s)
STREAM (Stream Smoother) <e>	This improves elements that reduce picture quality mainly noticeable in network contents, such as mosquito noise and block noise.	OFF ON
V.ADJ (Advanced Video Adjust)	Sets the optimum picture quality for the type of monitor that is connected. Select PDP for plasma displays, LCD for liquid crystal monitors, FPJ for front projectors, PRO for professional monitors. If you want to adjust the picture quality settings to your personal tastes, select MEMORY .	PDP LCD FPJ PRO MEMORY
YNR <d, e>	Reduces noise in the luminance (Y) signal.	◀ 0 to +8 ▶ Default: 0
CNR <d, e>	Reduces noise in the input's color (C) signal.	◀ 0 to +8 ▶ Default: 0
BNR <d, e>	Reduces block noise (block-shaped distortion generated upon MPEG compression) in the picture.	◀ 0 to +8 ▶ Default: 0
MNR <d, e>	Reduces mosquito noise (distortion generated at the contours of the picture upon MPEG compression) in the picture.	◀ 0 to +8 ▶ Default: 0
DETAIL <d, e>	Adjusts how sharp edges appear.	◀ -4 to +4 ▶ Default: 0
BRIGHT (Brightness) <d, e>	Adjusts the overall brightness.	◀ -6 to +6 ▶ Default: 0
CONTRAST <d, e>	Adjusts the contrast between light and dark.	◀ -6 to +6 ▶ Default: 0
HUE <d, e>	Adjusts the red/green balance.	◀ -6 to +6 ▶ Default: 0
CHROMA (Chroma Level) <d, e>	Adjusts saturation from dull to bright.	◀ -6 to +6 ▶ Default: 0
BLK SETUP (Black Setup) <f>	Sets the black level according to the video input signal. Normally select 7.5 . If the dark parts of the picture are all black with this setting, select 0 .	7.5 0
ASP (Aspect) <g>	Specifies the aspect ratio when input signals are output at the HDMI output. Make your desired settings while checking each setting on your display (if the image doesn't match your monitor type, cropping or black bands appear).	THROUGH NORMAL

a If the video picture deteriorates when this settings is switched **ON**, switch it **OFF**.

- b
- When set to a resolution with which the TV (monitor) is not compatible, no picture is output. Also, in some cases no picture will be output due to copyright protection signals. In this case, change the setting.
 - When **AUTO** is selected, the resolution is selected automatically according to the capacity of the TV (monitor) connected by HDMI. When **PURE** is selected, the signals are output with the same resolution as when input (see *About the video converter* on page 16).
 - If this is set to something other than **AUTO**, **PURE** and 480i/576i analog signals are input, 480p/576p signals are output from the component output terminals.

- c • This setting is valid for component outputs and HDMI output.
 - **P.MOTION** is disabled when **PCINEMA** is set to **ON**.
 - This setting have the effect only for pictures recorded in the interlaced scan format (480i/576i or 1080i signals).
- d Adjustment is not possible unless **V.ADJ** (Advanced Video Adjust) is set to **MEMORY**.
- e • This setting is only displayed when the video signals below are being input:
 - 480i, 576i, 480p, 576p, 720p, 1080i analog video signals
 - 480i, 576i, 480p, 576p, 720p, 1080i, 1080p, 1080p24 HDMI video signals
- f This adjustment is only possible when 480i signals are being input from the composite video jacks.
- g • If the image doesn't match your monitor type, adjust the aspect ratio on the source component or on the monitor.
 - This setting is only displayed when 480i/p or 576i/p video signals are being input.

Switching the speaker terminals

If you selected **Normal(SB/FH)**, **Normal(SB/FW)** or **Speaker B** at *Speaker system setting* on page 69, you can switch between speakers using the **SPEAKERS** button. If you selected **Front Bi-Amp** or **ZONE 2**, the button will simply switch your main speaker terminals on or off.

● Use **SPEAKERS** on the front panel to select a speaker system setting.

As mentioned above, if you have selected **Front Bi-Amp** or **ZONE 2**, the button will simply switch your main speaker terminal (A) on or off. Press repeatedly to choose a speaker terminal option:

*When you select **Normal(SB/FH)**, you can select from:*

- **SP: SB/FH ON** – Surround back or front height channels are added to the front, center and surround channels (maximum 5 channels) and a maximum of 7 channels are output. The surround back and front height channels are switched automatically according to the audio input signal.
- **SP: SB ON** – Surround back channels are added to the front, center and surround channels (maximum 5 channels) and a maximum of 7 channels are output.
- **SP: FH ON** – Front height channels are added to the front, center and surround channels

(maximum 5 channels) and a maximum of 7 channels are output.

- **SP: OFF** – No sound is output from the speakers.

*When you select **Normal(SB/FW)**, you can select from:*

- **SP: SB/FW ON** – Surround back or front wide channels are added to the front, center and surround channels (maximum 5 channels) and a maximum of 7 channels are output. The surround back and front wide channels are switched automatically according to the audio input signal.
- **SP: SB ON** – Surround back channels are added to the front, center and surround channels (maximum 5 channels) and a maximum of 7 channels are output.
- **SP: FW ON** – Front wide channels are added to the front, center and surround channels (maximum 5 channels) and a maximum of 7 channels are output.
- **SP: OFF** – No sound is output from the speakers.

*When you select **Speaker B**, you can select from:*

- **SP: A ON** – Sound is output from the A-speaker terminals (up to 7 channels (including surround back channels), depending on the source).
- **SP: B ON** – Sound is output from the two speakers connected to the B-speaker terminals. Multichannel sources will not be heard.

- **SP: A+B ON** – Sound is output from the A-speaker terminals (up to 5 channels, depending on the source), the two speakers connected to the B-speaker terminals, and the subwoofer. The sound from the B-speaker terminals will be the same as the sound from the A-speaker terminals (multichannel sources will be downmixed to 2 channels).
- **SP: OFF** – No sound is output from the speakers.



Note

- The subwoofer output depends on the settings you made in *Manual speaker setup* on page 69. However, if **SP: B ON** is selected above, no sound is heard from the subwoofer (the LFE channel is not downmixed).
- All speaker systems (except **Speaker B** connections) are switched off when headphones are connected.

Using the MULTI-ZONE controls

The following steps use the front panel controls to adjust the sub zone volume and select sources. See *MULTI-ZONE remote controls* on page 54.



Important

The explanations for **ZONE 3** below only apply to the VSX-53.

1 Press **MULTI-ZONE ON/OFF** on the front panel.

Each press selects a MULTI-ZONE option:

- **ZONE 2 ON** – Selects your primary (**ZONE 2**) sub zone
- **ZONE 2&3 ON** – Select both sub zones
- **ZONE 3 ON** – Selects your secondary (**ZONE 3**) sub zone
- **MULTI ZONE OFF** – Switches the MULTI-ZONE feature off

The **MULTI-ZONE** indicator lights when the **MULTI-ZONE** control has been switched ON.

2 Press **MULTI-ZONE CONTROL** on the front panel to select the sub zone(s) you want.

If you selected **ZONE 2&3 ON** above, you can toggle between **ZONE 2** and **ZONE 3**.

- When the receiver is on, make sure that any operations for the sub zone are done while **ZONE** and your selected sub zone(s) show in the display. If this is not showing, the front panel controls affect the main zone only. If the receiver is in standby, the display is dimmed, and **ZONE** and your selected sub zone(s) continue to show in the display.

3 Use the **INPUT SELECTOR** dial to select the source for the zone you have selected.

For example, **ZONE 2 DVD** sends the source connected to the **DVD** inputs to the primary (**ZONE 2**) sub room.

- If you select **TUNER**, you can use the tuner controls to select a preset station (see *Saving station presets* on page 33 if you're unsure how to do this). The tuner cannot be tuned to more than one station at a time. Therefore, changing the station in one zone also changes the station in the other zone. Please be careful not to change stations when recording a radio broadcast.

4 When **Speaker System** is set to **ZONE 2**, use the **MASTER VOLUME** dial to adjust the volume for the sub zone.

5 When you're finished, press **MULTI-ZONE CONTROL** again to return to the main zone controls.

You can also press **MULTI-ZONE ON/OFF** on the front panel to switch off all output to the sub zone(s).

- You won't be able to switch the main zone off completely unless you've switched off the **MULTI-ZONE** control first.

- If you don't plan to use the MULTI-ZONE feature for a while, turn off the power in both the sub and main rooms so that this receiver is in standby.

MULTI-ZONE remote controls

Press the remote control's **ZONE 2** or **ZONE 3** to operate the corresponding zone.

The following table shows the possible MULTI-ZONE remote controls:

Button(s)	What it does
	Switches on/off power in the sub zone.
INPUT SELECT	Use to select the input function in the sub zone.
Input function buttons	Use to select the input function directly (this may not work for some functions) in the sub zone.
MASTER VOLUME +/- <a>	Use to set the listening volume in the sub zone.
MUTE <a>	Mutes the sound or restores the sound if it has been muted (adjusting the volume also restores the sound).

- a You can only use this button when **Speaker System** is set to **ZONE 2**.

Making an audio or a video recording

You can make an audio or a video recording from the built-in tuner, or from an audio or video source connected to the receiver (such as a CD player or TV).

Keep in mind you can't make a digital recording from an analog source or vice-versa, so make sure the components you are recording to/from are hooked up in the same way (see *Connecting your equipment* on page 11 for more on connections).

- The receiver's volume, Audio parameters (the tone controls, for example), and surround effects have no effect on the recorded signal.
- Some digital sources are copy-protected, and can only be recorded in analog.
- Some video sources are copy-protected. These cannot be recorded.

Since the video converter is not available when making recordings (from the video **OUT** jacks) make sure to use the same type of video cable for connecting your recorder as you used to connect your video source (the one you want to record) to this receiver. For example, you must connect your recorder using Component video if your source has also been connected using Component video.

1 Select the source you want to record.

Use the input function buttons (or **INPUT SELECT**).

2 Prepare the source you want to record.

Tune to the radio station, load the CD, video, DVD etc.

3 Select the input signal according to the signal to be recorded.

Use the remote control's **SIGNAL SEL** button.

4 Prepare the recorder.

Insert a blank tape, MD, video etc. into the recording device and set the recording levels. Refer to the instructions that came with the recorder if you are unsure how to do this. Most video recorders set the audio recording level automatically-check the component's instruction manual if you're unsure.

5 Start recording, then start playback of the source component.

Reducing the level of an analog signal

The input attenuator lowers the input level of an analog signal when it's too strong. You can use this if you find that the **OVER** indicator lights often or you can hear distortion in the sound. The attenuator isn't available with digital sources, or when using the Stream Direct (ANALOG DIRECT) modes.

- Press **RECEIVER** to the receiver operation mode, then press **A.ATT** to switch the input attenuator on or off.

Using the sleep timer

The sleep timer switches the receiver into standby after a specified amount of time so you can fall asleep without worrying about the receiver being left on all night. Use the remote control to set the sleep timer.

- Press **RECEIVER** to the receiver operation mode, then press **SLEEP** repeatedly to set the sleep time.



- You can check the remaining sleep time at any time by pressing **SLEEP** once. Pressing repeatedly will cycle through the sleep options again.
- The sleep timer is valid for all zones. If any zone is on, the sleep timer continues functioning.

Dimming the display

You can choose between four brightness levels for the front panel display. Note that when selecting sources, the display automatically brightens for a few seconds.

- Press **RECEIVER** to the receiver operation mode, then press **DIMMER** repeatedly to change the brightness of the front panel display.

- You can also choose to turn the display off. In this case, the **FL OFF** indicator lights.

Switching the HDMI output

VSX-53 only

Set which terminal to use when outputting video and audio signals from the HDMI output terminals.

The **HDMI OUT 1** terminal is compatible with the **Control** with HDMI function.

- Press **RECEIVER** to the receiver operation mode, then press **HDMI OUT**.

Please wait a while when **Please wait ...** is displayed.

The output switches among **HDMI OUT ALL**, **HDMI OUT 1** and **HDMI OUT 2** each time the button is pressed.

- The synchronized amp mode is canceled when the HDMI output is switched. If you wish to use the synchronized amp mode, switch to **HDMI OUT 1**, then select the synchronized amp mode on the TV using the TV's remote control.

Checking your system settings

Use the status display screen to check your current settings for features such as surround back channel processing and your current MCACC preset.

1 Press **RECEIVER** to the receiver operation mode, then press **STATUS** to check the system settings.

The front panel display shows each of the following settings for three seconds each: **Input Source** → **Sampling Frequency** → **MCACC preset** → **ZONE 2 input** → **ZONE 3 input** (VSX-53 only) → **HDMI OUT** (VSX-53 only).

2 When you're finished, press **STATUS** again to switch off the display.

Resetting the system

Use this procedure to reset all the receiver's settings to the factory default. Use the front panel controls to do this. Set MULTI-ZONE to **MULTI ZONE OFF**.

- Disconnect the iPod and USB memory device from the receiver beforehand.
- Set the **Control** with HDMI to **OFF** (see *HDMI Setup* on page 47).

1 Switch the receiver into standby.

2 While holding down **ENTER** on the front panel, press **STANDBY/ON**.

The display shows **RESET ◀ NO ▶**.

3 Select '**RESET**' using **PRESET** (←/→), then press **ENTER** on the front panel.

The display shows **RESET? OK**.

4 Press **ENTER** to confirm.

OK appears in the display to indicate that the receiver has been reset to the factory default settings.

- Note that all settings will be saved, even if the receiver is unplugged.

Default system settings

Setting	Default
Digital Video Converter	ON
SPEAKERS	SB/FH
Speaker System	Normal (SB/FH)
	Front SMALL
	Center SMALL
Speaker Setting	FH/FW SMALL
	Surr SMALL
	SB SMALLx2
	SW YES
Surround Position	IN REAR
Crossover	80 Hz
X-Curve	OFF
DIMMER	Brightest
Inputs	
See <i>Input function default and possible settings</i> on page 28.	
HDMI	
HDMI Audio	Amp
<i>VSX-53 only:</i> HDMI output	HDMI OUT ALL
Control	ON
Control Mode	PQLS
Display Power Off	NO
Audio playback	
Power On Level	LAST
Volume Limit	OFF
Mute Level	FULL
Phase Control	ON
Auto Sound Retriever	iPod/USB, HOME MEDIA GALLERY, ADAPTER PORT input function ON
	Other input functions OFF

Setting	Default
Sound Delay	0.0 frame
Dual Mono	CH1
DRC	AUTO
SACD Gain	0 dB
LFE Attenuate	0 dB
Auto delay	OFF
Digital Safety	OFF
Effect Level	ExtendedStereo 90
	Other modes 50
PL II Music Options	Center Width 3
	Dimension 0
	Panorama OFF
Neo:6 Options	Center Image
	Neo:6 CINEMA: 10
	Neo:6 MUSIC: 3
PL IIz Options	Height Gain MID
	Listening Mode (2 ch/multi ch) AUTO
All Inputs	Listening Mode (Headphones) SURROUND
	STEREO
See also <i>Setting the Audio options</i> on page 50 for other default DSP settings.	
MCACC	
MCACC Position Memory	M1: MEMORY 1
Channel Level (M1 to M6)	0.0 dB
Speaker Distance (M1 to M6)	10'00"
Standing Wave (M1 to M6)	ATT of all channels/filters 0.0 dB
	SWch Wide Trim 0.0 dB
EQ Data (M1 to M6)	All channels/bands 0.0 dB
	EQ Wide Trim 0.0 dB

Controlling the rest of your system

About the Remote Setup menu

The Remote Setup mode is set by pressing the number button while pressing **RCU SETUP**. The different items on the Remote Setup menu are described below. For their setting procedures, refer to the explanations for the respective items.

Setting	What it does
Presets recall	Presets codes can be set for the various input functions. The remote control codes of a number of other devices (including products of other brands) are preset in the remote control to allow these devices to be operated. See <i>Selecting preset codes directly</i> on page 56 .
Code learning	If the desired operations cannot be performed even though you have set the preset codes, the remote control signals of other devices can be learned directly. See <i>Programming signals from other remote controls</i> on page 57 .
Multi operation	A series of the remote control operations for starting listening or viewing can be programmed. Multiple remote control codes can be set for the different input functions. See <i>Multi Operation and System Off</i> on page 58 .
System off	This is a function for automatically turning off the power of devices connected to the receiver. Multiple remote control codes can be set, as desired. See <i>Multi Operation and System Off</i> on page 58 .

Setting	What it does
Direct function	This is a setting for changing only the remote control unit's operation screen, without changing the receiver's input, when the remote control unit's input function buttons are pressed. This is convenient for using the remote control unit for devices not connected to the receiver. See <i>Direct function</i> on page 57 .
Erase learning	This function is used to erase remote control codes that have been learned. Codes learned for the different input functions can be erased individually. See <i>Erasing one of the remote control button settings</i> on page 57 .
Back light	The backlight lighting pattern can be selected from among four modes, in consideration of convenience and battery service life. See <i>Setting the backlight mode</i> on page 58 .
Reset function	This is a function for resetting preset codes that have been set. Key resetting can be done for individual input functions. See <i>Erasing all learnt settings that are in one input function</i> on page 57 .
All reset	This is a function for resetting all remote control unit settings you have made to the defaults set upon shipment from the factory. See <i>Resetting the remote control settings</i> on page 59 .
Change RC mode	If you have multiple Pioneer receivers, amplifiers, etc., this setting can be used to prevent other units from operating simultaneously when the remote control unit is operated. See <i>Operating multiple receivers</i> on page 56 .



Note

- You can cancel or exit any of the steps by pressing **RCU SETUP**.
- After one minute of inactivity, the remote automatically exits the operation.

Operating multiple receivers

Up to four receivers can be operated discretely using this receiver's remote control when using multiple receivers, provided they are of the same model as this receiver. The receiver to be operated is switched by inputting the preset code to set the remote control setting.

- Set the remote modes on the receivers before using this function (see *Remote Control Mode Setup* on page 74).

1 Press and hold RCU SETUP, then press '4' for three seconds.

Release the button after the LED flashes once. The LED continues to flash.

- To cancel the preset setup mode press **RCU SETUP**.

2 Press the number button for the receiver ("Receiver 1" to "Receiver 4") you wish to operate.

For example, to operate "Receiver 2", press '2'. If the LED lights for one second and continues to flash, the setting has been successfully completed.

When the preset code is input, the LED flashes three times to indicate that the setting has failed.

Setting the remote to control other components

Most components can be assigned to one of the input function buttons (such as **DVD** or **CD**)

using the component's manufacturer preset code stored in the remote.

However, there are cases where only certain functions may be controllable after assigning the proper preset code, or the codes for the manufacturer in the remote control will not work for the model that you are using.

If you can't find a preset code that matches the component you want to control, you can still teach the remote individual commands from another remote control (see *Programming signals from other remote controls* on page 57).

- For greater convenience, assign the TV connected to the **MONITOR OUT** terminal to the **TV CTRL** button, and assign your satellite/cable receiver or set-top box connected to the **TV/SAT** input terminal to the **TV/SAT** input button. If a single device is connected to both terminals, that device should be assigned to both the **TV CTRL** and **TV/SAT** input buttons.
- Devices may be assigned to the following input function buttons.

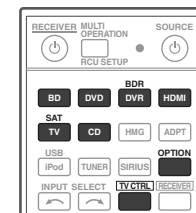

Selecting preset codes directly

1 Press and hold RCU SETUP, then press '1' for three seconds.

Release the button after the LED flashes once. The LED continues to flash.

- To cancel the preset setup mode press **RCU SETUP**.

2 Press the input function button for the component you want to control.

When assigning preset codes to **TV CONTROL**, press **TV CTRL** here.

The LED blinks once and flashes continuously.

3 Use the number buttons to enter the 4-digit preset code.

See *Preset code list* on page 96.

If the LED lights for one second and continues to flash, the setting has been successfully completed.

When the preset code is fully input, the LED flashes three times to indicate that the setting has failed. If this happens, enter the 4-digit preset code again.

4 Repeat steps 2 through 3 for the other components you want to control.

To try out the remote control, switch the component on or off (into standby) by pressing **⏻ SOURCE**. If it doesn't seem to work, select the next code from the list (if there is one).

5 Press RCU SETUP to exit the preset setup mode.

Programming signals from other remote controls

If the preset code for your component is not available, or the available preset codes do not operate correctly, you can program signals from the remote control of another component. This can also be used to program additional operations (buttons not covered in the presets) after assigning a preset code.

The remote can store about 120 preset codes from other components (this has been tested with codes of Pioneer format only).

Certain buttons represent operations that cannot be learned from other remote controls. The buttons available are shown below:

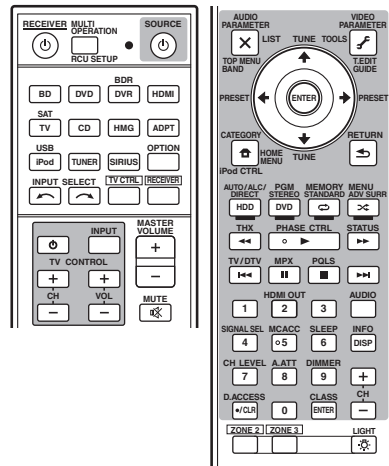

1 Press and hold RCU SETUP, then press '2' for three seconds.

Release the button after the LED flashes once. The LED continues to flash.

- To cancel the preset setup mode press **RCU SETUP**.

2 Press the input function button for the component you want to control.

The LED blinks once and flashes continuously.

3 Point the two remote controls towards each other, then press the button that will be doing the learning on this receiver's remote control.

The LED flashes once, then stops flashing, remaining lit.

- The remote controls should be 3 cm (1 inch) apart.

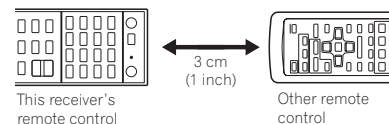

4 Press the corresponding button on the other remote control that is sending (teaching) the signal to this receiver's remote control.

If the LED lights for one second and continues to flash, the setting has been successfully completed.

- If the LED flashes for five seconds, it means the memory is full. See *Erasing all learnt settings that are in one input function* on page 57 to erase a programmed button you're not using to free up more memory (note that some signals may take more memory than others).
- Note that interference from TVs or other devices will sometimes result in the remote control learning the wrong signal.
- Some commands from other remote controls cannot be learned, but in most cases the remotes just need to be moved closer together or farther apart.

5 To program additional signals for the current component repeat steps 3 and 4.

To program signals for another component, exit and repeat steps 2 through 4.

6 Press RCU SETUP to exit the programming mode.

Erasing one of the remote control button settings

This erases one of the buttons you have programmed and restores the button to the factory default.

1 Press and hold RCU SETUP, then press '7' for three seconds.

Release the button after the LED flashes once. The LED continues to flash.

- To cancel the preset setup mode press **RCU SETUP**.

2 Press the input function button corresponding to the command to be erased, then press ENTER.

The LED flashes once.

3 Press and hold the button to be erased for three seconds.

If the LED lights for one second, the erasing has been successfully completed.

4 Repeat step 3 to erase other buttons.

5 Press RCU SETUP to exit the erasing mode.

Erasing all learnt settings that are in one input function

This operation erases all the operational settings of other devices that have been programmed in one input function, and restores the factory default.

This function is handy for erasing all data programmed for devices no longer being used.

1 Press and hold RCU SETUP, then press '9' for three seconds.

Release the button after the LED flashes once. The LED continues to flash.

- To cancel the preset setup mode press **RCU SETUP**.

2 Press and hold the input function button corresponding to the command to be erased for three seconds.

If the LED lights for one second, the erasing has been successfully completed.

Direct function

- Default setting: **On**

You can use the direct function feature to control one component using the remote control while at the same time, using your receiver to playback a different component. This could let

you, for example, use the remote control to set up and listen to a CD on the receiver, and then use the remote control to rewind a tape in your VCR while you continue to listen to your CD player.

When direct function is on, any component you select (using the input function buttons) will be selected by both the receiver and the remote control. When you turn direct function off, you can operate the remote control without affecting the receiver.

1 Press and hold RCU SETUP, then press '5' for three seconds.

Release the button after the LED flashes once. The LED continues to flash.

- To cancel the preset setup mode press **RCU SETUP**.

2 Press the input function button for the component you want to control.

3 Press '1' (On) or '0' (Off) to switch the direct function mode.

If the LED lights for one second and continues to flash, the setting has been successfully completed.

If the LED flashes three times, the setting has failed.

4 Press RCU SETUP to exit the setup.

Setting the backlight mode

• Default setting: **1** (normal mode)
The backlight lighting pattern can be selected from among four modes, in consideration of convenience and battery service life.

1 Press and hold RCU SETUP, then press '6' for three seconds.

Release the button after the LED flashes once. The LED continues to flash.

- To cancel the preset setup mode press **RCU SETUP**.

2 Press the number button for the backlight mode you want to set.

- **'1'** (normal mode) – The backlight is turned on and off with the light button. After it lights, it turns off automatically if no operation is performed for 10 seconds.
- **'2'** (frequent lighting mode) – The backlight turns on when any button on the remote control is pressed. It is turned off with the light button. After it lights, it turns off automatically if no operation is performed for 10 seconds.
- **'3'** (eco mode) – The backlight is turned on and off with the light button. After it lights, it turns off automatically if no operation is performed for 5 seconds.
- **'4'** (off mode) – The backlight does not turn on even when the light button is pressed.

If the LED lights for one second and continues to flash, the setting has been successfully completed.

If the LED flashes three times, the setting has failed.

3 Press RCU SETUP to exit the setup.

Multi Operation and System Off

The Multi operation feature allows you to program a series of up to 5 commands for the components in your system.

- Be sure to call up the preset codes of devices or perform programming signals for other remote controls before multi operation memory programming (page 57).

The Multi operation feature makes it easy to perform the following operations by pressing just two buttons.

Press **MULTI OPERATION** and then the **DVD** input function button to:

1. Switch this receiver on.
2. Switch this receiver's input to DVD.

3. Transmit a sequence of up to five programmed commands.

Similar to Multi operations, System off allows you to use two buttons to stop and switch off a series of components in your system at the same time. Only one System off operation sequence may be programmed.

Press **MULTI OPERATION** and then **⓪ SOURCE** to:

1. Transmit a sequence of up to five programmed commands.
 2. Switch off all Pioneer devices including the receiver (except DVD recorders and VCRs).
- For greater convenience, program this receiver to perform power on/off and playback operations on non-Pioneer devices as well. (The signals for Pioneer devices described above are not contingent on programming for non-Pioneer devices.)

The buttons that can be programmed using Multi operation or System off are the same buttons as those that can be programmed for other remote controls (see *Programming signals from other remote controls* on page 57).



Note

- Before Multi operation and System off will work correctly, you must setup the remote to work with your TV and other components (see *Setting the remote to control other components* on page 56 for more on this).
- Some units may take some time to power up, in which case multiple operations may not be possible.
- Power on and off commands only work with components that have a standby mode.
- Some remote controllers for other manufacturers' devices use the same signals for switching the power on and off. In some cases, even if this receiver is programmed to perform these commands, power to the non-Pioneer devices may not be switched on and

off correctly. Program the receiver to perform these commands if the non-Pioneer device uses separate signals for power on/off.

Programming a multi-operation or a shutdown sequence

1 Press and hold RCU SETUP, then press '3' for three seconds.

Release the button after the LED flashes once. The LED continues to flash.

- To cancel the preset setup mode press **RCU SETUP**.

2 Press the input function button (or ⓪ SOURCE button).

For *Multi operations*, press the input function you wish to program (for example, if you want to start the sequence by switching on your DVD player, press **DVD**).

- With Multi operation, the **HDMI** and **TV CTRL** settings cannot be made. For other settable input functions, see *Setting the remote to control other components* on page 56.

For *System off*, press the **⓪ SOURCE** button. The LED blinks twice and flashes continuously.

3 If necessary, press the input function button for the component whose command you want to input.

This is only necessary if the command is for a new component (input function).

4 Select the button for the command you want to input.

The LED blinks once and flashes continuously.

- You don't need to program the receiver to switch on or off. This is done automatically. With Pioneer components, you don't need to program the power to switch off in a shutdown sequence (except DVD recorders).

5 Repeat steps 3 to 4 to program a sequence of up to five commands.

If you press **RCU SETUP** before programming is completed, commands programmed up to that point will be stored.

6 Press RCU SETUP to exit the programming mode.

Using multi operations

1 Press MULTI OPERATION.

Release the button after the LED flashes once. The LED continues to flash.

2 Within five seconds, press an input function button that has been set up with a multi operation.

The receiver switches on (if it was in standby) and the programmed multi operation is performed automatically.

Using System off

1 Press MULTI OPERATION.

Release the button after the LED flashes once. The LED continues to flash.

2 Within five seconds, press SOURCE.

The command sequence you programmed will run, then all Pioneer components will switch off, followed by this receiver (switch of all the zones becomes off).

- In order to avoid accidentally switching off a DVD recorder that is currently recording, no DVD recorder power off codes are sent.

Erasing the settings for the multi-operation

This erases all the settings programmed in the remote control for the multi-operation.

1 Press and hold RCU SETUP, then press '8' for three seconds.

Release the button after the LED flashes once. The LED continues to flash.

- To cancel the preset setup mode press **RCU SETUP**.

2 Press the input function button containing the program you want to cancel or the SOURCE button for three seconds.

If the LED lights for one second, the erasing has been successfully completed.

Resetting the remote control settings

Use this procedure to reset all the remote control's settings to the factory default.

- When preset codes are set, all the signals learned in the input function buttons are cleared. This function is convenient when you want to reset some but not all of input function buttons.

1 Press and hold RCU SETUP, then press '0' for three seconds.

Release the button after the LED flashes once. The LED continues to flash.

2 Press and hold the ENTER button for three seconds.

If the LED lights for one second, the erasing has been successfully completed.

Default preset codes

Input function button	Preset code
DVD	2158
BD	2160
DVR/BDR	2150
HDMI	2159
TV/SAT	0116
CD	5066
TV CTRL	0116

Controlling components

This remote control can control components after entering the proper codes (see *Setting the remote to control other components* on page 56 for more on this). Use the input function buttons to select the component.

- The **TV CONTROL** buttons on the remote control are dedicated to control the TV assigned to the **TV CTRL** button. If you have two TVs, assign the main TV to the **TV CTRL** button.

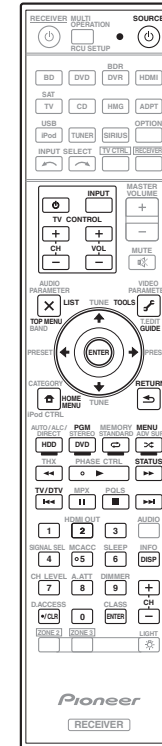

TV and Audio/Video components

Button(s)	TV	TV (Monitor)	BD/DVD	HDD/BDR/DVR	VCR	SAT/CATV
SOURCE	POWER ON/OFF	POWER ON/OFF	POWER ON/OFF	POWER ON/OFF	POWER ON/OFF	POWER ON/OFF
Number buttons	<i>numerics</i>	<i>numerics</i>	<i>numerics</i>	<i>numerics</i>	<i>numerics</i>	<i>numerics</i>
•/CLR	(dot)	KURO LINK	CLEAR	+	—	*
ENTER (CLASS)	CH ENTER	CH ENTER	ENTER	ENTER	—	ENTER
X	EXIT/INFO	EXIT	TOP MENU	TOP MENU	—	LIST
	TOOLS/GUIDE/EPG	USER MENU	TOOLS <a>	GUIDE	—	GUIDE
					—	
ENTER	ENTER	ENTER	ENTER	ENTER	—	ENTER
	HOME MENU	HOME MENU	HOME MENU	HOME MENU	—	HOME MENU
	RETURN	RETURN	RETURN	RETURN	—	RETURN
HDD (Red)	<i>Red</i>	<i>Red</i>	—	HDD	—	<i>Red</i>
DVD (Green)	<i>Green</i>	<i>Green</i>	—	DVD	—	<i>Green</i>
(Yellow)	<i>Yellow</i>	<i>Yellow</i>	—	VCR	—	<i>Yellow</i>
(Blue)	<i>Blue</i>	<i>Blue</i>	MENU	MENU	—	<i>Blue</i>
	—	—				
	—	AUTO SETUP				
	—	FREEZE				
	—	—				
	—	—				
	ANT	AV SELECTION			—	
	—	SCREEN SIZE			—	
AUDIO	AUDIO	AUDIO	AUDIO	AUDIO	AUDIO	AUDIO
DISP	DISPLAY	DISPLAY	DISPLAY	DISPLAY	—	DISPLAY/INFO
CH +/-	CH +/-	CH +/-	OUTPUT RESOLUTION +/- <a>	CH +/-	CH +/-	CH +/-

a Controls for BD.

















Audio/Video components

Button(s)	LD	CD/CD-R/SACD	MD/DAT	TAPE
SOURCE	POWER ON/OFF	POWER ON/OFF	POWER ON/OFF	POWER ON/OFF
Number buttons	<i>numerics</i>	<i>numerics</i>	<i>numerics</i>	—
•/CLR	+10	>10/CLEAR	CLEAR <a>	CLEAR
ENTER (CLASS)	ENTER	DISC/ENTER	OPEN/CLOSE <a>	ENTER
X	TOP MENU	—	—	MS←
	—	LEGATO LINK 	—	MS→
		—	—	
ENTER	ENTER	—	—	—
	—	SACD SETUP 	—	—
	RETURN	—	—	—
AUDIO	AUDIO	PURE AUDIO 	—	—
DISP	DISPLAY/INFO	TIME 	—	—

a Controls for MD.

b Controls for SACD.

TV (Projector)

Button(s)	TV (Projector)
 SOURCE	POWER ON
1	MOVIE
2	STANDARD
3	DYNAMIC
4	USER1
5	USER2
6	USER3
7	COLOR+
8	SHARP+
9	GAMMA
0	COLOR-
 /CLR	SHARP-
ENTER (CLASS)	COLOR TEMP
	EXIT
	INFO
	
ENTER	ENTER
	TEST
	HIDE
	MENU
	HDMI1
	HDMI2
	COMP.
	VIDEO
	S-VIDEO
	BRIGHT-
	BRIGHT+
AUDIO	POWER OFF
DISP	ASPECT
CH +/-	CONTRAST+/-

The Advanced MCACC menu

Making receiver settings from the Advanced MCACC menu

The Advanced MCACC (Multi Channel ACoustic Calibration) system was developed in Pioneer's laboratories with the aim of making it possible for home users to perform adjustments of the same level as in a studio easily and with high precision. The acoustic characteristics of the listening environment are measured and the frequency response is calibrated accordingly to allow high precision, automatic analysis and optimal calibration of the sound field to bring it closer to a studio environment than ever before. Furthermore, while it was previously difficult to eliminate standing waves, this receiver is equipped with a standing wave control function using a unique process to perform acoustic analysis and reduce their influence. This section describes how to calibrate the sound field automatically and fine-adjust the sound field data manually.

1 Press **RECEIVER** to switch on the receiver and your TV.

Make sure that the TV's video input is set to this receiver.

2 Press **RECEIVER** on the remote control, then press **HOME MENU**.

A Graphical User Interface (GUI) screen appears on your TV. Use **↑/↓/←/→** and **ENTER** to navigate through the screens and select menu items. Press **RETURN** to exit the current menu.

- Press **HOME MENU** at any time to exit the Home Menu.

3 Select 'Advanced MCACC' from the Home Menu, then press **ENTER**.

4 Select the setting you want to adjust.

- **Full Auto MCACC** – See *Automatically conducting optimum sound tuning (Full Auto MCACC)* on page 26 for a quick and effective automatic surround setup.
- **Auto MCACC** – See *Automatic MCACC (Expert)* on page 62 for a more detailed MCACC setup.
VSX-53 only: In addition, the Full Band Phase Control function calibrates the frequency-phase characteristics of the connected speakers.
- **Manual MCACC** – Fine-tunes your speaker settings and customizes the Acoustic Calibration EQ (see *Manual MCACC setup* on page 64).
- **Demo** – No settings are saved and no errors occur. When the speakers are connected to this receiver, the test tone is output repeatedly. Press **RETURN** to cancel the test tone.

Automatic MCACC (Expert)

If your setup requires more detailed settings than those provided in *Automatically conducting optimum sound tuning (Full Auto MCACC)* on page 26, you can customize your setup options below. You can calibrate your system differently for up to six different MCACC presets, which are useful if you have different listening positions depending on the type of source (for example, watching movies from a sofa, or playing a video game close to the TV).



Important

- Make sure the microphone/speakers are not moved during the Auto MCACC Setup.

- The screen saver will automatically appear after five minutes of inactivity.

CAUTION

- The test tones used in the Auto MCACC Setup are output at high volume.

1 Select 'Auto MCACC' from the Advanced MCACC menu, then press **ENTER**.

If the **Advanced MCACC** screen is not displayed, refer to *Making receiver settings from the Advanced MCACC menu* on page 62.

2 Select the parameters you want to set.

Use **↑/↓** to select the item, then use **←/→** to set.

- **Auto MCACC** – The default is **ALL** (recommended), but you can limit the system calibration to only one setting (to save time) if you want.
 - When data measurement is taken (after selecting **ALL** or **Keep SP System**), the reverb characteristics data (both before- and after-calibration) that this receiver had been storing will be overwritten.
 - When measurement is performed with other than **SYMMETRY** (after selecting **ALL** or **Keep SP System**), the reverberation characteristics after calibration cannot be predicted, so the graph for the characteristics after calibration ("After") cannot be displayed. If you will need to display the graph for the characteristics after calibration ("After"), take the measurement using the **EQ Professional** menu in the **Manual MCACC** setup (page 64).
 - The **EQ Pro & S-Wave** measurement is also taken when **ALL** or **Keep SP System** is selected. See *Acoustic Calibration EQ Professional* on page 65 for more on this.
 - Either effect of Acoustic Calibration EQ Professional and Standing Wave can

be switched on and off in the respective MCACC preset. For details, see *Setting the Audio options* on page 50.

- **EQ Type** (only available when the **Auto MCACC** Menu above is **EQ Pro & S-Wave**) – This determines how the frequency balance is adjusted.

After a single calibration is performed, each of the following three correction curves can be stored separately in the MCACC memory. **SYMMETRY** implements symmetric correction for each pair of left and right speakers to flatten the frequency-amplitude characteristics. **ALL CH ADJ** is a 'flat' setting where all the speakers are set individually so no special weighting is given to any one channel. **FRONT ALIGN** sets all speakers in accordance with the front speaker settings (no equalization is applied to the front left and right channels). If you selected **ALL** or **Keep SP System** as your **Auto MCACC** menu, you can specify the MCACC preset where you want to save the **SYMMETRY**, **ALL CH ADJ** and **FRONT ALIGN** settings.

- **THX Speaker** (only available when the **Auto MCACC** Menu above is **ALL** or **Speaker Setting**) – Select **YES** when using THX speakers (all speakers other than the front speakers are set to **SMALL**). In other cases, leave at **NO**.
- **STAND.WAVE Multi-Point** (only available when the **Auto MCACC** Menu above is **EQ Pro & S-Wave**) – In addition to measurements at the listening position, you can use two more reference points for which test tones will be analyzed for standing waves. This is useful if you want to get a balanced 'flat' calibration for several seating positions in your listening area. Place the microphone at the reference point indicated on-screen and note that the last microphone placement will be at your main listening position:

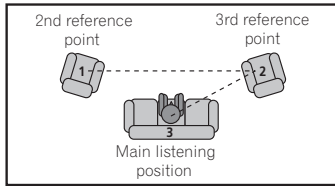

3 Connect the microphone to the MCACC SETUP MIC jack on the front panel.

Make sure there are no obstacles between the speakers and the microphone.

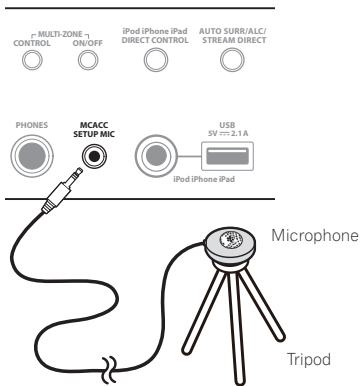

If you have a tripod, use it to place the microphone so that it's about ear level at your normal listening position. If you do not have a tripod, use some other object to install the microphone.

- It may not be possible to measure correctly if the microphone is placed on a table, sofa, etc.

4 When you're finished setting the options, select START then press ENTER.

5 Follow the instructions on-screen.

6 Wait for the Auto MCACC Setup to finish outputting test tones.

A progress report is displayed on-screen while the receiver outputs test tones to determine the speakers present in your setup. Try to be as quiet as possible while it's doing this.

- With error messages (such as **Too much ambient noise!** or **Check microphone.**), select **RETRY** after checking for ambient noise (see *Problems when using the Auto MCACC Setup* on page 27) and verifying the mic connection. If there doesn't seem to be a problem, you can simply select **GO NEXT** and continue.
- Do not adjust the volume during the test tones. This may result in incorrect speaker settings.

7 If necessary, confirm the speaker configuration in the GUI screen.

The configuration shown on-screen should reflect the actual speakers you have. If no operations are performed for 10 seconds while the speaker configuration check screen is being displayed, the Auto MCACC Setup will resume automatically. In this case, you don't need to select **'OK'** and press **ENTER** in step 8.

- If you see an **ERR** message (or the speaker configuration displayed isn't correct), there may be a problem with the speaker connection. If selecting **RETRY** doesn't work, turn off the power and check the speaker connections. If there doesn't seem to be a problem, you can simply use **↑/↓** to select the speaker and **←/→** to change the setting and continue.
- If the speaker is not pointed to the microphone (listening position) or when using speakers that affect the phase (dipole speakers, reflective speakers, etc.), **Reverse Phase** may be displayed even if the speakers are properly connected.

If **Reverse Phase** is displayed, the speaker's wiring (+ and -) may be inverted. Check the speaker connections.

- If the connections were wrong, turn off the power, disconnect the power cord, then reconnect properly. After this, perform the Auto MCACC procedure again.
- If the connections were right, select **GO NEXT** and continue.

8 Make sure 'OK' is selected, then press ENTER.

A progress report is displayed on-screen while the receiver outputs more test tones to determine the optimum receiver settings. Again, try to be as quiet as possible while this is happening. It may take 3 to 7 minutes.

- If you selected a **STAND.WAVE Multi-Point** setup (in step 2), you will be asked to place the mic at the 2nd and 3rd reference points before finally placing it at your main listening position.

9 The Auto MCACC Setup procedure is completed and the Advanced MCACC menu reappears automatically.

The settings made in the Auto MCACC Setup should give you excellent surround sound from your system, but it is also possible to adjust these settings manually using the **Manual MCACC** setup menu (starting below) or **Manual SP Setup** menu (starting on page 69).

- Depending on the characteristics of your room, sometimes identical speakers with cone sizes of around 12 cm (5 inches) will end up with different size settings. You can correct the setting manually using the *Manual speaker setup* on page 69.

- The subwoofer distance setting may be farther than the actual distance from the listening position. This setting should be accurate (taking delay and room characteristics into account) and generally does not need to be changed.
- If Auto MCACC Setup measurement results are incorrect due to the interaction of the speakers and viewing environment, we recommend adjusting the settings manually.

You can also choose to view the settings by selecting individual parameters from the **MCACC Data Check** screen (see *Checking MCACC Data* on page 66).

Press **RETURN** after you have finished checking each screen. When you're finished, select **RETURN** to go back to the **Home Menu**.

Be sure to disconnect the microphone from this receiver upon completion of the Auto MCACC Setup.

Manual MCACC setup

You can use the settings in the **Manual MCACC** setup menu to make detailed adjustments when you're more familiar with the system. Before making these settings, you should have already completed *Automatically conducting optimum sound tuning (Full Auto MCACC)* on page 26.

You only need to make these settings once (unless you change the placement of your current speaker system or add new speakers).



CAUTION

- The test tones used in the **Manual MCACC** setup are output at high volume.



Important

- Press the **MCACC** button while the pertinent setup screens are displayed to select MCACC presets.
- For some of the settings below, you'll have to connect the setup microphone to the front panel and place it about ear level at your normal listening position. Press **HOME MENU** to display the **Home Menu** before you connect the microphone to this receiver.
- See *Problems when using the Auto MCACC Setup* on page 27 for notes regarding high background noise levels and other possible interference.
- If you're using a subwoofer, switch it on and turn up the volume to the middle position.

1 Select 'Manual MCACC' from the Advanced MCACC menu.

See *Making receiver settings from the Advanced MCACC menu* on page 62 if you're not already at this screen.

2 Select the setting you want to adjust.

If you're doing this for the first time, you might want to make these settings in order.

- Fine Channel Level** – Make fine adjustments to the overall balance of your speaker system (see *Fine Channel Level* on page 64).
- Fine SP Distance** – Make precise delay settings for your speaker system (see *Fine Speaker Distance* on page 64).
- Standing Wave** – Control overly resonant low frequencies in your listening room (see *Standing Wave* on page 64).

The last two settings are specifically for customizing the parameters explained in *Acoustic Calibration EQ Adjust* on page 65:

- EQ Adjust** – Manually adjust the frequency balance of your speaker system while listening to test tones (see *Acoustic Calibration EQ Adjust* on page 65).
- EQ Professional** – Calibrate your system based on the direct sound coming from the speakers and make detailed settings according to your room's reverb characteristics (see *Acoustic Calibration EQ Professional* on page 65).

Fine Channel Level

- Default setting: **0.0dB** (all channels)

You can achieve better surround sound by properly adjusting the overall balance of your speaker system. You can adjust the Channel Level of each speaker in 0.5 dB increments. The following setting can help you make detailed adjustments that you may not achieve using the *Manual speaker setup* on page 69.

1 Select 'Fine Channel Level' from the Manual MCACC setup menu.

The volume increases to the 0.0 dB reference level.

2 Adjust the level of the left channel.

This will be the reference speaker level, so you may want to keep the level around **0.0dB** so that you'll have plenty of room to adjust the other speaker levels.

- After pressing **ENTER**, test tones will be output.

3 Select each channel in turn and adjust the levels (+/-12.0 dB) as necessary.

Use \leftarrow/\rightarrow to adjust the volume of the speaker you selected to match the reference speaker. When it sounds like both tones are the same volume, press \downarrow to confirm and continue to the next channel.

- For comparison purposes, the reference speaker will change depending on which speaker you select.
- If you want to go back and adjust a channel, simply use \uparrow/\downarrow to select it.

4 When you're finished, press RETURN.

You will return to the **Manual MCACC** setup menu.

Fine Speaker Distance

- Default setting: **10'00"** (all speakers)

For proper sound depth and separation with your system, it is necessary to add a slight bit of delay to some speakers so that all sounds will arrive at the listening position at the same time. You can adjust the distance of each speaker in half inch increments. The following setting can help you make detailed adjustments that you may not achieve using the *Manual speaker setup* on page 69.

1 Select 'Fine SP Distance' from the Manual MCACC setup menu.

2 Adjust the distance of the left channel from the listening position.

3 Select each channel in turn and adjust the distance as necessary.

Use \leftarrow/\rightarrow to adjust the delay of the speaker you selected to match the reference speaker. Listen to the reference speaker and use it to measure the target channel. From the listening position, face the two speakers with your arms outstretched pointing at each speaker. Try to

make the two tones sound as if they are arriving simultaneously at a position slightly in front of you and between your arm span.

- If you can't seem to achieve this by adjusting the distance setting, you may need to change the angle of your speakers very slightly.
- The subwoofer's test tone differs in tone from other channels. Adjust so that the sound of the subwoofer can be heard distinctly. Note that when adjusting the subwoofer, depending on the low frequency response of your speaker, it may be difficult to hear the change even when the setting is increased or decreased or when the position of the speaker is changed. Note that it may be difficult to compare this tone with the other speakers in your setup (depending on the low frequency response of the reference speaker).

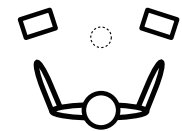

When it sounds like the delay settings are matched up, press \downarrow to confirm and continue to the next channel.

- For comparison purposes, the reference speaker will change depending on which speaker you select.
- If you want to go back and adjust a channel, simply use \uparrow/\downarrow to select it.

4 When you're finished, press RETURN.

You will return to the **Manual MCACC** setup menu.

Standing Wave

- Default setting: **ON/ATT 0.0dB** (all filters)
- Acoustic standing waves occur when, under certain conditions, sound waves from your speaker system resonate mutually with sound

waves reflected off the walls in your listening area. This can have a negative effect on the overall sound, especially at certain lower frequencies. Depending on speaker placement, your listening position, and ultimately the shape of your room, it results in an overly resonant ('boomy') sound. The Standing Wave Control uses filters to reduce the effect of overly resonant sounds in your listening area. During playback of a source, you can customize the filters used for Standing Wave Control for each of your MCACC presets.

- Standing Wave control filter settings cannot be changed during playback of sources using the HDMI connection.

1 Select 'Standing Wave' from the Manual MCACC setup menu.

2 Adjust the parameters for the Standing Wave Control.

- **Filter Channel** – Select the channel to which you will apply the filter(s): **MAIN** (all except center channel and subwoofer), **Center** or **SW** (subwoofer).
- **TRIM** (only available when the filter channel above is **SW**) – Adjust the subwoofer channel level (to compensate for the difference in output post-filter).
- **Freq / Q / ATT** – These are the filter parameters where **Freq** represents the frequency you will be targeting and **Q** is the bandwidth (the higher the Q, the narrower the bandwidth, or range) of the attenuation (**ATT**, the amount of reduction to the targeted frequency).

3 When you're finished, press RETURN.

You will return to the **Manual MCACC** setup menu.

Acoustic Calibration EQ Adjust

- Default setting: **ON/0.0dB** (all channels/bands)

Acoustic Calibration Equalization is a kind of room equalizer for your speakers (excluding the subwoofer). It works by measuring the acoustic characteristics of your room and neutralizing the ambient characteristics that can color the original source material (providing a 'flat' equalization setting). If you're not satisfied with the adjustment provided in *Automatically conducting optimum sound tuning (Full Auto MCACC)* on page 26 or *Automatic MCACC (Expert)* on page 62, you can also adjust these settings manually to get a frequency balance that suits your tastes.

1 Select 'EQ Adjust' from the Manual MCACC setup menu.

2 Select the channel(s) you want and adjust to your liking.

Use \uparrow/\downarrow to select the channel.

Use \leftarrow/\rightarrow to select the frequency and \uparrow/\downarrow to boost or cut the EQ. When you're finished, go back to the top of the screen and press \leftarrow to return to **Ch**, then use \uparrow/\downarrow to select the channel.

- The **OVER!** indicator shows in the display if the frequency adjustment is too drastic and might distort. If this happens, bring the level down until **OVER!** disappears from the display.

3 When you're finished, press RETURN.

You will return to the **Manual MCACC** setup menu.



Note

- Changing the frequency curve of one channel too drastically will affect the overall balance. If the speaker balance seems uneven, you can raise or lower channel levels using test tones with the **TRIM** feature. Use \leftarrow/\rightarrow to select **TRIM**, then use \uparrow/\downarrow to raise or lower the channel level for the current speaker.

Acoustic Calibration EQ Professional

This setup minimizes the unwanted effects of room reverberation by allowing you to calibrate your system based on the direct sound coming from the speakers.

Performing the Acoustic Calibration EQ Professional procedure is effective when the lower frequencies seem overly reverberant in your listening room (i.e. it sounds 'boomy') as shown at Type A below, or when different channels seem to exhibit different reverb characteristics as shown at Type B.

• Type A: Reverberance of high vs. low frequencies

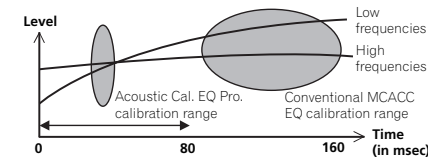

• Type B: Reverb characteristics for different channels

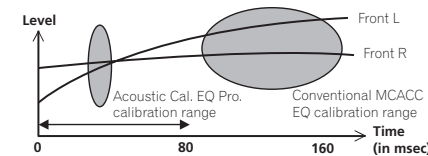

Using Acoustic Calibration EQ Professional

1 Select 'EQ Professional', then press ENTER.

2 Select an option and press ENTER.

- **Reverb Measurement** – Use this to measure the reverb characteristics before and after calibration.

- **Reverb View** – You can check the reverb measurements made for specified frequency ranges in each channel.

— If the **Reverb View** procedure is performed after the *Automatically conducting optimum sound tuning (Full Auto MCACC)* on page 26 or **Reverb Measurement** operation, depending on the standing wave control setting, differences may appear on the reverb graph. With the **Auto MCACC** function, the reverberations are measured with the standing waves controlled, so the reverb characteristics graph shows the characteristics with the effect of the standing waves eliminated. By contrast, the **Reverb Measurement** function measures the reverberations without controlling the standing waves, so the graph indicates the reverb characteristics including the effect of the standing waves. If you wish to check the reverb characteristics of the room itself (with the standing waves as such), we recommend using the **Reverb Measurement** function.

- **Advanced EQ Setup** – Use this to select the time period that will be used for frequency adjustment and calibration, based on the reverb measurement of your listening area. Note that customizing system calibration using this setup will alter the settings you made in *Automatically conducting optimum sound tuning (Full Auto MCACC)* on page 26 or *Automatic MCACC (Expert)* on page 62 and is not necessary if you're satisfied with these settings.

3 If you selected 'Reverb Measurement', select EQ ON or EQ OFF, and then START.

The following options determine how the reverb characteristics of your listening area are displayed in **Reverb View**:

- **EQ OFF** – You will see the reverb characteristics of your listening area without the equalization performed by this receiver (before calibration).
- **EQ ON** – You will see the reverb characteristics of your listening area with the equalization performed by this receiver (after calibration). Note that the EQ response may not appear entirely flat due to adjustments necessary for your listening area.
 - The calibration corresponding to the currently selected MCACC preset will be used when **EQ ON** is selected. To use another MCACC preset, press **MCACC** to select the MCACC memory you want to store.
 - After auto calibration with **EQ Type : SYMMETRY (Full Auto MCACC, etc.)**, the graph for the inferred reverb characteristics can be displayed by selecting **Reverb View**. To display the actually measured reverb characteristics after EQ calibration, measure with **EQ ON**.

When the reverb measurement is finished, you can select **Reverb View** to see the results on-screen. See *Professional Calibration EQ graphical output* on page 79 for troubleshooting information.

4 If you selected 'Reverb View', you can check the reverb characteristics for each channel. Press RETURN when you're done.

The reverb characteristics are displayed when the **Full Auto MCACC** or **Reverb Measurement** measurements are conducted.

Use **←/→** to select the channel, frequency and calibration setting you want to check. Use **↑/↓** to go back and forth between the three. The reverb characteristics graph before and after EQ calibration can be displayed by selecting **Calibration : Before / After**. Note that the

markers on the vertical axis indicate decibels in 2 dB steps.

5 If 'Advanced EQ Setup' is selected, select the MCACC memory to be stored, then enter the desired time setting for calibration, and then select START.

- To specify the place where the MCACC memory is to be stored, press **MCACC** to select the MCACC memory you want to store.

Based on the reverb measurement above, you can choose the time period that will be used for the final frequency adjustment and calibration. Even though you can make this setting without reverb measurement, it is best to use the measurement results as a reference for your time setting. For an optimal system calibration based on the direct sound coming from the speakers, we recommend using the **30-50ms** setting. Use **←/→** to select the setting. Use **↑/↓** to switch between them.

Select the setting from the following time periods (in milliseconds): **0-20ms, 10-30ms, 20-40ms, 30-50ms, 40-60ms, 50-70ms** and **60-80ms**. This setting will be applied to all channels during calibration.

When you're finished, select **START**. It will take about 2 to 4 minutes for the calibration to finish. After the Acoustic Calibration Equalization is set, you are given the option to check the settings on-screen.

Checking MCACC Data

At the procedure of *Automatically conducting optimum sound tuning (Full Auto MCACC)* on page 26, the procedure of *Automatic MCACC (Expert)* on page 62 or after fine-adjusting at *Manual MCACC setup* on page 64, you can check your calibrated settings using the GUI screen.

1 Press **RECEIVER** on the remote control, then press **HOME MENU**.

A Graphical User Interface (GUI) screen appears on your TV. Use **↑/↓/←/→** and **ENTER** to navigate through the screens and select menu items. Press **RETURN** to exit the current menu.

2 Select 'MCACC Data Check' from the Home Menu.

3 Select the setting you want to check.

- **Speaker Setting** – Used to check the settings of the speaker systems. See *Speaker Setting* on page 66 for more on this.
- **Channel Level** – Used to check the output level of the different speakers. See *Channel Level* on page 66 for more on this.
- **Speaker Distance** – Used to check the distance to the different speakers. See *Speaker Distance* on page 66 for more on this.
- **Standing Wave** – Used to check the standing wave control filter settings. See *Standing Wave* on page 67 for more on this.
- **Acoustic Cal EQ** – Used to check the calibration values of the listening environment's frequency response. See *Acoustic Cal EQ* on page 67 for more on this.
- **Group Delay (VSX-53 only)** – Used to check the speakers' group delay (both before and after calibration). See *Group Delay* on page 67 for more on this.

4 Press **RETURN** to go back to the MCACC Data Check menu, repeating steps 2 and 3 to check other settings.

5 When you're finished, press **RETURN**.

You will return to the **Home Menu**.

Speaker Setting

Use this to display the speaker size and number of speakers. See *Speaker Setting* on page 69 for more on this.

1 Select 'Speaker Setting' from the MCACC Data Check menu.

2 Select the channel you want to check.

Use **↑/↓** to select the channel. The corresponding channel on the layout diagram is highlighted.

Channel Level

Use this to display the level of the various channels. See *Channel Level* on page 70 for more on this.

1 Select 'Channel Level' from the MCACC Data Check menu.

2 When 'MCACC' is highlighted, use **←/→** to select the MCACC preset you want to check.

The level of the various channels set at the selected MCACC preset is displayed. '---' is displayed for channels that are not connected.

Speaker Distance

Use this to display the distance from the different channels to the listening position. See *Speaker Distance* on page 70 for more on this.

1 Select 'Speaker Distance' from the MCACC Data Check menu.

2 When 'MCACC' is highlighted, use **←/→** to select the MCACC preset you want to check.

The distance from the various channels set at the selected MCACC preset is displayed. '---' is displayed for channels that are not connected.

Standing Wave

Use this to display the standing wave related adjustment values for the various MCACC memories. See *Standing Wave* on page 64 for more on this.

- 1 Select 'Standing Wave' from the MCACC Data Check menu.
- 2 When 'Filter Channel' is highlighted, use \uparrow/\downarrow to select the channel for which you want to check standing wave control.

The standing wave related calibration value for the selected channel stored at the selected MCACC preset and its graph are displayed.

- 3 Press \leftarrow to highlight 'MCACC', then use \uparrow/\downarrow to select the MCACC preset you want to check.

Acoustic Cal EQ

Use this to display the calibration values for the frequency response of the various channels set in the different MCACC presets. See *Acoustic Calibration EQ Adjust* on page 65 for more on this.

- 1 Select 'Acoustic Cal EQ' from the MCACC Data Check menu.
- 2 When 'Ch' is highlighted, use \uparrow/\downarrow to select the channel.

The calibration value for the frequency response of the selected channel stored at the selected MCACC preset and its graph are displayed.

- 3 Press \leftarrow to highlight 'MCACC', then use \uparrow/\downarrow to select the MCACC preset you want to check.

Group Delay

V5X-53 only

Use this to display the calibrated speaker group delay results. See *Better sound using Phase Control and Full Band Phase Control* on page 39 for more on this.

- 1 Select 'Group Delay' from the MCACC Data Check menu.
- 2 When 'Channel' is highlighted, use \leftarrow/\rightarrow to select the channel you want to check.

The result of group delay calibration for the selected channel is displayed.

When measurements have been performed with **Full Auto MCACC** selected at **Advanced MCACC** or with **ALL** or **Full Band Phase Ctrl** selected when **Auto MCACC** is selected, the graph before group delay calibration is also displayed. When **After** is selected at **Calibration**, the group delay after calibration is displayed. Compared to when **Before** is selected, with **After** there is less difference in the delay between frequency bands and the group delay between the different channels is uniform, allowing you to check the full band phase control effect. **No Data** is displayed if the selected group delay has not been measured.

Data Management

This system allows you to store up to six MCACC presets, allowing you to calibrate your system for different listening positions (or frequency adjustments for the same listening position). This is useful for alternate settings to match the kind of source you're listening to and where you're sitting (for example, watching movies from a sofa, or playing a video game close to the TV).

From this menu you can copy from one preset to another, name presets for easier identification and clear any ones you don't need.

- This can be done in *Automatically conducting optimum sound tuning (Full Auto MCACC)* on page 26 or *Automatic MCACC (Expert)* on page 62, either of which you should have already completed.

- 1 Press **RECEIVER** on the remote control, then press **HOME MENU**.

A Graphical User Interface (GUI) screen appears on your TV. Use $\uparrow/\downarrow/\leftarrow/\rightarrow$ and **ENTER** to navigate through the screens and select menu items. Press **RETURN** to exit the current menu.

- 2 Select 'Data Management' from the Home Menu.

- 3 Select the setting you want to adjust.

- **Memory Rename** – Name your MCACC presets for easy identification (see *Renaming MCACC presets* on page 67).
- **MCACC Memory Copy** – Copy settings from one MCACC preset to another (see *Copying MCACC preset data* on page 67).
- **MCACC Memory Clear** – Clear any MCACC presets that you don't want (see *Clearing MCACC presets* on page 68).

Renaming MCACC presets

If you have several different MCACC presets that you're using, you may want to rename them for easier identification.

- 1 Select 'Memory Rename' from the Data Management setup menu.
- 2 Select the MCACC preset you want to rename, then select an appropriate preset name.

Use \uparrow/\downarrow to select the preset, then \leftarrow/\rightarrow to select a preset name.

- 3 Repeat for as many MCACC presets as necessary, then press **RETURN** when you're finished.

You will return to the **Data Management** setup menu.

Copying MCACC preset data

If you want to manually adjust the Acoustic Calibration EQ (see *Manual MCACC setup* on page 64), we recommend copying your current settings to an unused MCACC preset. Instead of just a flat EQ curve, this will give you a reference point from which to start.

- The settings made in *Automatically conducting optimum sound tuning (Full Auto MCACC)* on page 26 or *Automatic MCACC (Expert)* on page 62.

- 1 Select 'MCACC Memory Copy' from the Data Management setup menu.

- 2 Select the setting you want to copy.

- **All Data** – Copies all the settings of the selected MCACC preset memory.
- **Level & Distance** – Copies only the channel level and speaker distance settings of the selected MCACC preset memory.

3 Select the MCACC preset you'll be copying the settings 'From', then specify where you want to copy them ('To').

Make sure you don't overwrite an MCACC preset you're currently using (this can't be undone).

4 Select 'OK' to confirm and copy the settings.

When **MCACC Memory Copy?** is displayed, select **YES**. If **NO** is selected, the memory is not copied.

Completed! shows in the GUI screen to confirm the MCACC preset has been copied, then you automatically return to the **Data Management** setup menu.

Clearing MCACC presets

If you are no longer using one of the MCACC presets stored in memory, you can choose to clear the calibration settings of that preset.

1 Select 'MCACC Memory Clear' from the Data Management setup menu.

2 Select the MCACC preset you want to clear.

Make sure you don't clear an MCACC preset you're currently using (this can't be undone).

3 Select 'OK' to confirm and clear the preset.

When **MCACC Memory Clear?** is displayed, select **YES**. If **NO** is selected, the memory is not cleared.

Completed! shows in the GUI screen to confirm the MCACC preset has been cleared, then you automatically return to the **Data Management** setup menu.

The System Setup and Other Setup menus

Making receiver settings from the System Setup menu

The following section describes how to change the speaker-related settings manually and make various other settings (input selection, OSD language selection, etc.).

1 Press **RECEIVER** to switch on the receiver and your TV.

Make sure that the TV's video input is set to this receiver.

2 Press **RECEIVER** on the remote control, then press **HOME MENU**.

A Graphical User Interface (GUI) screen appears on your TV. Use **↑/↓/←/→** and **ENTER** to navigate through the screens and select menu items. Press **RETURN** to exit the current menu.

- Press **HOME MENU** at any time to exit the Home Menu.

3 Select 'System Setup' from the Home Menu, then press **ENTER**.

4 Select the setting you want to adjust.

- **Manual SP Setup** – Sets the type of connection used for surround back terminals and the size, number distance and overall balance of the connected speakers (see *Manual speaker setup* on page 69).
- **Input Setup** – Specifies what you've connected to the digital, HDMI and component video inputs (see *The Input Setup menu* on page 28).
- **OSD Language** – The GUI screen's display language can be changed (see *Changing the OSD display language (OSD Language)* on page 26).

- **Network Setup** – Conducts the setup necessary to connect this unit to the network (see *Network Setup menu* on page 71).
- **HDMI Setup** – Synchronizes this receiver with your Pioneer component supporting **Control with HDMI** (page 47).
- **Other Setup** – Makes customized settings to reflect how you are using the receiver (see *The Other Setup menu* on page 73).

Manual speaker setup

This receiver allows you to make detailed settings to optimize the surround sound performance. You only need to make these settings once (unless you change the placement of your current speaker system or add new speakers). These settings are designed to customize your system, but if you're satisfied with the settings made in *Automatically conducting optimum sound tuning (Full Auto MCACC)* on page 26, it isn't necessary to make all of these settings.



CAUTION

- The test tones used in the **Manual SP Setup** are output at high volume.

1 Select 'Manual SP Setup', then press **ENTER**.

See *Making receiver settings from the System Setup menu* on page 69 if you're not already at this screen.

2 Select the setting you want to adjust.

If you are doing this for the first time, you may want to adjust these settings in order:

- **Speaker System** – Specifies how you are using your surround back speaker terminals and B speaker terminals (page 69).
- **Speaker Setting** – Specifies the size and number of speakers you've connected (page 69).
- **Channel Level** – Adjusts the overall balance of your speaker system (page 70).
- **Speaker Distance** – Specifies the distance of your speakers from the listening position (page 70).
- **X-Curve** – Adjusts the tonal balance of your speaker system for movie soundtracks (page 71).
- **THX Audio Setting** – Specifies whether you are using a THX speaker setup (page 71).

3 Make the adjustments necessary for each setting, pressing **RETURN** to confirm after each screen.

Speaker system setting

- Default setting: **Normal(SB/FH)**

There are several ways you can use the speaker terminals with this receiver. In addition to a normal home theater setup where they are used for the front height speakers or front wide speakers, they can be used for bi-amping the front speakers or as an independent speaker system in another room.

1 Select 'Speaker System' from the Manual SP Setup menu.

See *Making receiver settings from the System Setup menu* on page 69 if you're not already at this screen.

2 Select the speaker system setting.

- **Normal(SB/FH)** – Select for normal home theater use with front height speakers in your main (speaker system A) setup.
- **Normal(SB/FW)** – Select for normal home theater use with front wide speakers in your main (speaker system A) setup.

- **Speaker B** – Select to use the B speaker terminals to listen to stereo playback in another room (see *Switching the speaker terminals* on page 53).
- **Front Bi-Amp** – Select this setting if you're bi-amping your front speakers (see *Bi-amping your speakers* on page 15).
- **ZONE 2** – Select to use the surround back speaker terminals for an independent system in another zone (see *Using the MULTI-ZONE controls* on page 53).

3 If you selected **Normal(SB/FH)**, **Normal(SB/FW)**, or **Speaker B** in Step 2, select the placement of the surround speakers.

In a 7.1-channel surround system with surround speakers placed directly at the sides of the listening position, the surround sound of 5.1-channel sources is heard from the side.

This function mixes the sound of the surround speakers with the surround back speakers so that the surround sound is heard from diagonally to the rear as it should be.

Depending on the positions of the speakers and the sound source, in some cases it may not be possible to achieve good results. In this case, set the setting to **ON SIDE** or **IN REAR**.

- **ON SIDE** – Select when the surround speakers is positioned right beside you.
- **IN REAR** – Select when the surround speaker is positioned obliquely behind you.

4 When 'Setting Change?' is displayed, select **Yes**.

If **No** is selected, the setting is not changed. You will return to the **Manual SP Setup** menu.

Speaker Setting

Use this setting to specify your speaker configuration (size, number of speakers and crossover frequency). It is a good idea to make sure that the settings made in *Automatically conducting optimum sound tuning (Full Auto MCACC)*

on page 26 are correct. Note that this setting applies to all MCACC presets, and cannot be set independently.

- If you're using a THX speaker setup, set all speakers to **SMALL**.

1 Select 'Speaker Setting' from the Manual SP Setup menu.

2 Choose the set of speakers that you want to set, then select a speaker size.

Use \leftarrow/\rightarrow to select the size (and number) of each of the following speakers:

- **Front** – Select **LARGE** if your front speakers reproduce bass frequencies effectively, or if you didn't connect a subwoofer. Select **SMALL** to send the bass frequencies to the subwoofer.
- **Center** – Select **LARGE** if your center speaker reproduces bass frequencies effectively, or select **SMALL** to send bass frequencies to the other speakers or subwoofer. If you didn't connect a center speaker, choose **NO** (the center channel is sent to the front speakers).
- **FH** – Select **LARGE** if your front height speakers reproduce bass frequencies effectively, or select **SMALL** to send bass frequencies to the other speakers or subwoofer. If you didn't connect front height speakers, choose **NO** (the front height channel is sent to the front speakers).
 - You can adjust this setting only when **Speaker System** setting is **Normal(SB/FH)**.
 - If the surround speakers are set to **NO**, this setting will automatically be set to **NO**.
- **FW** – Select **LARGE** if your front wide speakers reproduce bass frequencies effectively, or select **SMALL** to send bass frequencies to the other speakers or subwoofer. If you didn't connect front wide speakers, choose **NO** (the front wide channel is sent to the front speakers).
 - You can adjust this setting only when **Speaker System** setting is **Normal(SB/FW)**.
 - If the surround speakers are set to **NO**, this setting will automatically be set to **NO**.
- **Surr** – Select **LARGE** if your surround speakers reproduce bass frequencies effectively. Select **SMALL** to send bass frequencies to the other speakers or subwoofer. If you didn't connect surround speakers choose **NO** (the sound of the surround channels is sent to the front speakers or a subwoofer).
- **SB** – Select the number of surround back speakers you have (one, two or none). Select **LARGEx2** or **LARGEx1** if your surround back speakers reproduce bass frequencies effectively. Select **SMALLx2** or **SMALLx1** to send bass frequencies to the other speakers or subwoofer. If you didn't connect surround back speakers choose **NO**.
 - If you selected **ZONE 2** or **Front Bi-Amp** (in *Speaker system setting* on page 69) you can't adjust the surround back settings.
 - If the surround speakers are set to **NO**, the surround back speakers will automatically be set to **NO**.
- **SW** – LFE signals and bass frequencies of channels set to **SMALL** are output from the subwoofer when **YES** is selected. Choose the **PLUS** setting if you want the subwoofer to output bass sound continuously or you want deeper bass (the bass frequencies that would normally come out the front and center speakers are also routed to the subwoofer). If you did not connect a subwoofer choose **NO** (the bass frequencies are output from other speakers).
 - If you have a subwoofer and like lots of bass, it may seem logical to select **LARGE** for your front speakers and **PLUS** for the subwoofer. This may not, however, yield

the best bass results. Depending on the speaker placement of your room you may actually experience a decrease in the amount of bass due low frequency cancellations. In this case, try changing the position or direction of speakers. If you can't get good results, listen to the bass response with it set to **PLUS** and **YES** or the front speakers set to **LARGE** and **SMALL** alternatively and let your ears judge which sounds best. If you're having problems, the easiest option is to route all the bass sounds to the subwoofer by selecting **SMALL** for the front speakers.

If you select **NO** for the subwoofer the front speakers will automatically be fixed to **LARGE**. Also, the center, surround, surround back, front height and front wide speakers can't be set to **LARGE** if the front speakers are set to **SMALL**. In this case, all bass frequencies are sent to the subwoofer.

3 Select 'X. OVER' and set the crossover frequency.

Frequencies below this point will be sent to the subwoofer (or **LARGE** speakers).

- This setting decides the cutoff between bass sounds playing back from the speakers selected as **LARGE** or the subwoofer, and bass sounds playing back from those selected as **SMALL**. It also decides where the cutoff will be for bass sounds in the LFE channel.
- With **Full Auto MCACC** setup or **Auto MCACC** setup (**ALL** or **Speaker Setting**), the setting here will not apply and the crossover frequency will be automatically set. Crossover frequency is a frequency aimed at achieving the optimal sound field taking into account the bass capacity of all connected speakers and human aural characteristics.
- If you're using THX speakers, confirm that the crossover frequency is set to **80Hz**.

4 When you're finished, press RETURN.

You will return to the **Manual SP Setup** menu.

Channel Level

Using the channel level settings, you can adjust the overall balance of your speaker system, an important factor when setting up a home theater system.

1 Select 'Channel Level' from the Manual SP Setup menu.

The test tones will start.

2 Adjust the level of each channel using \leftarrow/\rightarrow .

Use \uparrow/\downarrow to switch speakers.

Adjust the level of each speaker as the test tone is emitted.

- If you are using a Sound Pressure Level (SPL) meter, take the readings from your main listening position and adjust the level of each speaker to 75 dB SPL (C-weighting/slow reading).

3 When you're finished, press RETURN.

You will return to the **Manual SP Setup** menu.



Note

- You can change the channel levels by press **RECEIVER** to the receiver operation mode, then press **CH LEVEL**, and then using \leftarrow/\rightarrow on the remote control.

Speaker Distance

For good sound depth and separation from your system, you need to specify the distance of your speakers from the listening position. The receiver can then add the proper delay needed for effective surround sound.

1 Select 'Speaker Distance' from the Manual SP Setup menu.

2 Adjust the distance of each speaker using ←/→.

You can adjust the distance of each speaker in 1/2 inch Increments.

3 When you're finished, press RETURN.

You will return to the **Manual SP Setup** menu.



Note

- For best surround sound, make sure the surround back speakers are the same distance from the listening position.

X-Curve

Most soundtracks mixed for cinema sound too bright when played back in large rooms. The X-Curve setting acts as a kind of re-equalization for home theater listening, and restores proper tonal balance of movie soundtracks. Since the principal is the same, X-Curve isn't applied when you're using any of the Home THX, Pure direct or Optimum surround modes.

1 Select 'X-Curve' from the Manual SP Setup menu.

2 Choose the X-Curve setting you want.

Use ←/→ to adjust the setting. The X-Curve is expressed as a downwards slope in decibels per octave, starting at 2 kHz. The sound becomes less bright as the slope increases (to a maximum of **-3.0dB/oct**). Use the following guidelines to set the X-Curve according to your room size:

Room size (ft ²)	≤400	≤550	≤650	≤800	≤2200	≤12000
X-Curve (dB/oct)	-0.5	-1.0	-1.5	-2.0	-2.5	-3.0

- If you select **OFF**, the frequency curve will be flat and the X-Curve has no effect.

3 When you're finished, press RETURN.

THX Audio Setting

This menu allows the user to adjust various THX features including Loudness Plus, SBCh processing, THX Select2 Subwoofer (on/off), and Boundary Gain Control. Please see page 88 for details regarding these THX features.

1 Select 'THX Audio Setting' from the Manual SP Setup menu.

2 Select either ON or OFF for the THX Loudness Plus setting.

3 Specify whether the SBCh Processing is AUTO or MANUAL.

- AUTO** – When surround back speakers are connected, Dolby Digital EX signal is present in the audio signals being input is detected and the appropriate THX surround mode is set.
- MANUAL** – The desired THX surround mode can be selected regardless of whether or not surround back channel signals are present in the audio signals being input.

4 Specify whether your subwoofer is Select2 certified or not.

If your subwoofer isn't THX Select2 certified, but you still want to switch boundary gain compensation on, select **YES** here, but the effect might not work properly.

5 Select either ON or OFF for Boundary Gain Compensation setting.

6 When you're finished, press RETURN.

You will return to the **Manual SP Setup** menu.

Network Setup menu

Make the settings for connecting the receiver to the Internet and using the network functions.

1 Press **RECEIVER** on the remote control, then press **HOME MENU**.

A Graphical User Interface (GUI) screen appears on your TV. Use ↑/↓/←/→ and **ENTER** to navigate through the screens and select menu items. Press **RETURN** to exit the current menu.

2 Select 'System Setup' from the Home Menu.

3 Select 'Network Setup' from the System Setup menu.

4 Select the setting you want to adjust.

If you are doing this for the first time, you may want to adjust these settings in order:

- IP Address, Proxy** – Sets up the IP address/Proxy of this receiver (page 71).
- Network Standby** – Allows the AVNavigator or iControlAV2 function to be used even when the receiver is in the standby mode (page 72).
- Friendly Name** – The name of the receiver displayed on a computer or other device connected to the network can be changed (page 72).
- Parental Lock** – Restricts usage of network functions (page 72).
- Port Number Setting** – Sets the numbers of the ports where signals from IP Control are received (page 72).
- Wireless LAN Converter** – Used to make the wireless LAN converter's access point and IP address settings (page 72). For the wireless LAN converter, use the separately sold AS-WL300.

IP address/Proxy setting

In case the router connected to the LAN terminal on this receiver is a broadband router (with

a built-in DHCP server function), simply turn on the DHCP server function, and you will not need to set up the network manually. You must set up the network as described below only when you have connected this receiver to a broadband router without a DHCP server function. Before you set up the network, consult with your ISP or the network manager for the required settings. It is advised that you also refer to the operation manual supplied with your network component.

- In case you make changes to the network configuration without the DHCP server function, make the corresponding changes to the network settings of this receiver.

IP Address

The IP address to be entered must be defined within the following ranges. If the IP address defined is beyond the following ranges, you cannot play back audio files stored on components on the network or listen to Internet radio stations.

Class A: 10.0.0.1 to 10.255.255.254

Class B: 172.16.0.1 to 172.31.255.254

Class C: 192.168.0.1 to 192.168.255.254

Subnet Mask

In case an xDSL modem or a terminal adapter is directly connected to this receiver, enter the subnet mask provided by your ISP on paper. In most cases, enter 255.255.255.0.

Default Gateway

In case a gateway (router) is connected to this receiver, enter the corresponding IP address.

Primary DNS Server/ Secondary DNS Server

In case there is only one DNS server address provided by your ISP on paper, enter it in the **'Primary DNS Server'** field. In case there are more than two DNS server addresses, enter

'Secondary DNS Server' in the other DNS server address field.

Proxy Hostname/Proxy Port

This setting is required when you connect this receiver to the Internet via a proxy server. Enter the IP address of your proxy server in the 'Proxy Hostname' field. Also, enter the port number of your proxy server in the 'Proxy Port' field.

1 Select 'IP Address, Proxy' from the Network Setup menu.

2 Select the DHCP setting you want.

When you select **ON**, the network is automatically set up, and you do not need to follow Steps 3. Proceed with Step 4.

If there is no DHCP server on the network and you select **ON**, this receiver will use its own Auto IP function to determine the IP address.

- The IP address determined by the Auto IP function is 169.254.X.X. You cannot listen to an Internet radio station if the IP address is set for the Auto IP function.

3 Enter the IP Address, Subnet Mask, Default Gateway, Primary DNS Server and Secondary DNS Server.

Press \uparrow/\downarrow to select a number and \leftarrow/\rightarrow to move the cursor.

4 Select 'OFF' or 'ON' for the Enable Proxy Server setting to deactivate or activate the proxy server.

In case you select 'OFF', proceed with Step 7. In case you select 'ON', on the other hand, proceed with Step 5.

5 Enter the address of your proxy server or the domain name.

Use \uparrow/\downarrow to select a character, \leftarrow/\rightarrow to set the position, and **ENTER** to confirm your selection.

6 Enter the port number of your proxy server.

Use \uparrow/\downarrow to select a character, \leftarrow/\rightarrow to set the position, and **ENTER** to confirm your selection.

7 Select 'OK' to confirm the IP Address/Proxy setup.

Network Standby

This setting allows the AVNavigator or iControlAV2 function for operating the receiver from a computer connected on the same LAN as the receiver to be used even when the receiver is in the standby mode.

1 Select 'Network Standby' from the Network Setup menu.

2 Specify whether the Network Standby is ON or OFF.

- ON** – The AVNavigator or iControlAV2 function can be used even when the receiver is in the standby mode.
- OFF** – The AVNavigator or iControlAV2 function cannot be used when the receiver is in the standby mode (This lets you reduce power consumption in the standby mode).

Friendly Name

1 Select 'Friendly Name' from the Network Setup menu.

2 Select 'Edit Name' then select 'Rename'.

If after changing the name you want to restore the name to the default, select **Default**.

3 Input the name you want.

Use \uparrow/\downarrow to select a character, \leftarrow/\rightarrow to set the position, and **ENTER** to confirm your selection.

Parental Lock

Set restrictions for using Internet services. Also set the password accompanying the usage restrictions.

- Upon shipment from the factory, the password is set to "0000".



Important

When the **HOME MEDIA GALLERY** input is selected, the setting made here cannot be reflected. Set the input to something other than **HOME MEDIA GALLERY** before making this setting.

1 Select 'Parental Lock' from the Network Setup menu.

2 Input the password.

Use \uparrow/\downarrow to select a character, \leftarrow/\rightarrow to set the position, and **ENTER** to confirm your selection.

3 Specify whether to turn Parental Lock on or off.

- OFF** – Internet services are not restricted.
- ON** – Internet services are restricted.

4 If you want to change the password, select Change Password.

In this case, the procedure returns to step 2.

Port Number Setting

On this receiver, there can be up to 5 numbers of ports where signals are received. One of these, port 8102 which used for communicating with iControlAV2, cannot be changed, but the desired number can be set for the 4 other ports.

1 Select 'Port Number Setting' from the Network Setup menu.

2 Select the port number you want to change.

3 Input the port number.

- Use \uparrow/\downarrow to select a character, \leftarrow/\rightarrow to set the position, and **ENTER** to confirm your selection.
- It is not possible to set the same port number more than once.

4 If there are other port numbers you want to change, repeat steps 2 and 3.



Note

- When the wireless LAN converter (AS-WL300) is connected, the port number cannot be set to port 3.
- We recommend setting the port number to 23 or within the range of 49152 to 65535.
- When the port number is changed, network communications between the receiver and AVNavigator are no longer possible. In this case, click **Settings** on the AVNavigator's function menu, select the IP Address tab and input one of the port numbers set on the receiver side to enable communications with AVNavigator.

Wireless LAN Converter

This setting is required for connecting a wireless LAN converter to the receiver and using wireless network functions.

For the wireless LAN converter, use the separately sold AS-WL300.

Access Point Setting

Make the connection settings for the wireless LAN converter connected to the receiver and the access point. Connect the wireless LAN converter to the receiver and set DHCP on the "IP Address, Proxy" settings menu beforehand (page 71). There are four ways to make the settings for connecting to the access point, as shown below.

- WPS (PBC)** – Connection settings are made automatically simply by pressing the WPS buttons on the access point and wireless LAN converter, following the instructions displayed on the receiver's screen. This is the simplest way of making the settings, and is possible when the access point and wireless LAN converter are equipped with WPS buttons. Network connection settings require approximately 2 minutes from the time the

WPS buttons are pressed. Wait until the settings are completed.

- **WPS (PIN)** – Display a list of the SSIDs of connectable access points and select the access point to which you want to connect from this list. Connection settings are made by inputting the 8-digit PIN code displayed on the receiver's screen to the access point to which you want to connect.
- **Search for Access Point** – Display a list of the SSIDs of connectable access points and select the access point to which you want to connect from this list. Connection settings with the access point are made by setting the access point's security protocol, security key and WEP default key (only when the access point's security protocol is WEP).
- **Manual Setting** – Connection settings are made by manually inputting the SSID, security protocol, security key and WEP default key of the access point to which you want to connect.



Note

- If there is a ";" (semicolon) in the access point's SSID or security key, wireless LAN connection will not be possible even after the wireless LAN converter settings are completed. Change the setting of the access point's SSID or security key to a character string that does not include a ";" (semicolon).
- If it is not possible to connect to the access point with the **WPS (PBC)** or **WPS (PIN)** connection settings, we recommend making the connection settings at **Search for Access Point** or **Manual Setting**.

WLAN IP Address

If the IP address of a device connected in the LAN other than the wireless LAN converter is set to "192.168.XXX.249", the IP address of the wireless LAN converter will be redundant, making connection to the access point impossible.

In this case, use this setting to set an IP address specific to the wireless LAN converter.

1 Select 'Wireless LAN Converter' from the Network Setup menu.

2 Make the wireless LAN converter settings as necessary.

When making the connection settings of the wireless LAN converter and access point, select "**Access Point Setting**" and make the connection settings for the wireless LAN converter and access point following the instructions on the screen.

If you want to set the wireless LAN converter's IP address, select "**WLAN IP Address**" and input the IP address.

Checking the Network Information

The setting status of the following network-related items can be checked.

- **IP Address** – Check the IP address of this receiver.
- **MAC Address** – Check the MAC address of this receiver.
- **Friendly Name** – *Friendly Name* on page 72.
- **SSID** – Check the SSID of the access point connected with the wireless LAN converter (only when a wireless LAN converter is connected).

1 Press **RECEIVER** on the remote control, then press **HOME MENU**.

A Graphical User Interface (GUI) screen appears on your TV. Use **↑/↓/←/→** and **ENTER** to navigate through the screens and select menu items. Press **RETURN** to exit the current menu.

2 Select 'Network Information' from the Home Menu.

Display the setting status of the network-related items.

The Other Setup menu

The **Other Setup** menu is where you can make customized settings to reflect how you are using the receiver.

1 Press **RECEIVER** on the remote control, then press **HOME MENU**.

A Graphical User Interface (GUI) screen appears on your TV. Use **↑/↓/←/→** and **ENTER** to navigate through the screens and select menu items. Press **RETURN** to exit the current menu.

2 Select 'System Setup' from the Home Menu.

3 Select 'Other Setup', then press **ENTER**.

4 Select the setting you want to adjust.

If you are doing this for the first time, you may want to adjust these settings in order:

- **Auto Power Down** – Sets the power to turn off automatically when the receiver is not being used.
- **Volume Setup** – Sets up the volume-related operations of this receiver (page 74).
- **Remote Control Mode Setup** – Sets this receiver's remote control mode (page 74).
- **Flicker Reduction Setup** – Adjusts the way the GUI screen looks (page 74).
- **EXTENSION Setup** – Allows the CU-RF100 to be used even when the receiver is in the standby mode (page 74).
- **Software Update** – Use to update the receiver's software and check the version.
- **Pairing Bluetooth Setup** – Use to pair a *Bluetooth* ADAPTER and *Bluetooth* wireless technology device (page 35).

5 Make the adjustments necessary for each setting, pressing **RETURN** to confirm after each screen.

Auto Power Down

The power can be set to turn off automatically if no operation has been performed for a specific amount of time with no audio or video signals being input to the receiver. When using ZONE 2 or ZONE 3, the ZONE 2 or ZONE 3 power can also be set to turn off, but for ZONE 2 or ZONE 3 the power turns off automatically after the amount of time set here even if signals are being input or operations have been performed. Different times can be set for the main zone, ZONE 2 and ZONE 3.



Important

The explanations for ZONE 3 only apply to the VSX-53.

1 Select 'Auto Power Down' from the Other Setup menu.

2 Select the zone you want to set and set the time after which the power turns off.

- **MAIN** – The time can be selected from among "15 min", "30 min", "60 min" and "OFF". The power turns off after there has been no signal and no operation for the selected time.
- **ZONE 2** – The time can be selected from among "30 min", "1 hour", "3 hours", "6 hours", "9 hours" and "OFF". The power turns off after the selected time.
- **ZONE 3** – The time can be selected from among "30 min", "1 hour", "3 hours", "6 hours", "9 hours" and "OFF". The power turns off after the selected time.



Note

- Depending on the connected devices, the Auto Power Down function may not work properly due to excessive noise or other reasons.

Volume Setup

You can set the maximum volume of this receiver or specify what the volume level will be when the power is turned on.

1 Select 'Volume Setup' from the Other Setup menu.

2 Select the Power ON Level setting you want.

The volume can be set so that it is always set to the same level when the receiver's power is turned on.

- **LAST** (default) – When the power is turned on, the volume is set to the same level as when the power was last turned off.
- **"---** – When the power is turned on, the volume is set to minimum level.
- **-80.0dB to +12.0dB** – Specify the volume to be set when the power is turned on, in steps of 0.5 dB.

It is not possible to set a volume level greater than the value specified at Volume Limit setup (see below).

3 Select the Volume Limit setting you want.

Use this function to limit the maximum volume. The volume cannot be increased above the level set here, even by operating **MASTER VOLUME** button (or the dial on the front panel).

- **OFF** (default) – The maximum volume is not limited.
- **-20.0dB/-10.0dB/0.0dB** – The maximum volume is limited to the value set here.

4 Select the Mute Level setting you want.

This sets how much the volume is to be turned down when **MUTE** is pressed.

- **FULL** (default) – No sound.
- **-40.0dB/-20.0dB** – The volume will be turned down to the level specified here.

5 When you're finished, press RETURN.

You will return to the **Other Setup** menu.

Remote Control Mode Setup

- Default setting: **1**

This sets this receiver's remote control mode to prevent erroneous operation when multiple units of the receiver are being used.

1 Select 'Remote Control Mode Setup' from the Other Setup menu.

2 Select the Remote Control Mode setting you want.

3 Select 'OK' to change the remote control mode.

4 Follow the instructions on the screen to change the remote control's setting.

See *Operating multiple receivers* on page 56.

5 When you're finished, press RETURN.

You will return to the **Other Setup** menu.

Flicker Reduction Setup

- Default setting: **OFF**

The GUI screen's resolution can be increased. If you feel the GUI screen is hard to see, try changing this setting. Note that the resolution in this setting only affects the GUI screen; it has no influence on the video output.

1 Select 'Flicker Reduction Setup' from the Other Setup menu.

2 Select the Flicker Reduction setting you want.

3 When you're finished, press RETURN.

You will return to the **Other Setup** menu.

EXTENSION Setup

- Default setting: **OFF**

A separately sold the CU-RF100 can be used to operate the receiver by RF communications. To do so, set the **EXTENSION** setting to **ON**. When **ON** is set here, the receiver can be operated even when the receiver is in the standby mode.

1 Select 'EXTENSION Setup' from the Other Setup menu.

2 Select the EXTENSION setting you want.

3 When you're finished, press RETURN.

You will return to the **Other Setup** menu.

Software Update

Use this procedure to update the receiver's software and check the version. There are two ways to update: via the Internet and via a USB memory device.

Updating via the Internet is performed by accessing the file server from the receiver and downloading the file. This procedure is only possible if the receiver is connected to the Internet. Updating via a USB memory device is performed by downloading the update file from a computer, reading this file onto a USB memory device then inserting this USB memory device into the USB port on the receiver's front panel. With this procedure, the USB memory device containing the update file must first be inserted into the USB port on the receiver's front panel.

- If an update file is provided on the Pioneer website, download it onto your computer. When downloading an update file from the Pioneer website onto your computer, the file will be in ZIP format. Unzip the ZIP file before saving it on the USB memory device. If there are any old downloaded files or downloaded files for other models on the USB memory device, delete them.



Important

- DO NOT unplug the power cord during updating.
- When updating via the Internet, do not disconnect the LAN cable. When updating via a USB memory device, do not disconnect the USB memory device.

1 Select 'Software Update' from the Other Setup menu.

2 Select the update procedure.

- **Update via Internet** – The receiver checks whether updatable software is available via the Internet.
- **Update via USB Memory** – The receiver checks whether the USB memory device inserted into the USB port on the receiver's front panel contains updatable software. "Accessing" is displayed and the update file is checked. Wait a while.

3 Check on the screen whether or not an update file was found.

If "**New version found.**" is displayed, the update file has been found. The version number and updating time are displayed. If "**This is the latest version. There is no need to update.**" is displayed, no update file has been found.

4 To update, select OK.

The updating screen appears and updating is performed.

- The power turns off automatically once updating is completed.

Software Update messages

Status messages	Descriptions
NO UPDATE FILE	No update file was found on the USB memory device. Store the file in the USB memory device's root directory.
FILE ERROR	Try disconnecting then reconnecting the USB device or storing the update file again. If the error still occurs, try using a different USB memory device.
UPDATE ERROR 1 to UPDATE ERROR 7	Turn the receiver's power off, then turn it back on and try updating the software again.
Update via USB	If this message flashes, updating has failed. Update via a USB memory device. Put the update file on a USB memory device and connect the device to the USB port. When the file is found, software updating starts automatically.
UE11	Updating has failed. Use the same procedure to update the software again.
UE22	
UE33	

Additional information

Troubleshooting 1

Incorrect operations are often mistaken for trouble and malfunctions. If you think that there is something wrong with this component, check the points below. Sometimes the trouble may lie in another component. Investigate the other components and electrical appliances being used. If the trouble cannot be rectified even after exercising the checks listed below, ask your nearest Pioneer authorized independent service company to carry out repair work.

- If the unit does not operate normally due to external effects such as static electricity disconnect the power plug from the outlet and insert again to return to normal operating conditions.

If the problem is not solved after the troubleshooting below, if the screen freezes unexpectedly or if the buttons on the remote control or front panel stop working completely, do the following:

- Press **⏻** **STANDBY/ON** on the front panel to turn off the power, then turn the power back on.
- If the power cannot be turned off, press and hold **⏻** **STANDBY/ON** on the front panel for over 10 seconds. The power will turn off. (In this case, the various settings made on the receiver may be cleared.)

Power

Symptom	Remedy
The power does not turn on.	Make sure that the power cord is plugged in to an active power outlet. Try disconnecting from the power outlet, then plugging back in.
Power cannot be turned off. (ZONE 2 ON or ZONE 3 ON (VSX-53 only) is displayed.)	Press the remote control's ZONE 2 or ZONE 3 (VSX-53 only), then press ⏻ RECEIVER to switch the sub zone off.
The receiver suddenly switches off or the iPod iPhone iPad indicator blinks.	Check that there are no loose strands of speaker wire touching the rear panel or another set of wires. If so, re-attach the speaker wires, making sure there are no stray strands. The receiver may have a serious problem. Disconnect from the power and call a Pioneer authorized independent service company.
During loud playback the power suddenly switches off.	Turn down the volume. Lower the 63 Hz and 125 Hz equalizer levels in the <i>Manual MCACC setup</i> on page 64. Switch on the digital safety feature. While holding down ENTER on the front panel, press ⏻ STANDBY/ON to set this receiver to the standby mode. Use TUNE ↑/↓ to select D.SAFETY <OFF> , and then use PRESET ←/→ to select 1 or 2 (select D.SAFETY <OFF> to deactivate this feature). If the power switches off even with 2 switched on, turn down the volume. With 1 or 2 on, some features may be unavailable.
The unit does not respond when the buttons are pressed.	Try switching the receiver off, then back on again. Try disconnecting the power cord, then connect again.

Symptom	Remedy
AMP ERR blinks in the display, then the power automatically switches off. The ADVANCED MCACC blinks and the power does not turn on.	The receiver may have a serious problem. Do not try switching the receiver on. Unplug the receiver from the wall and call a Pioneer authorized independent service company.
AMP OVERHEAT blinks in the display and the FL OFF indicator flash and the power turns off.	Allow the unit to cool down in a well-ventilated place before switching back on (see <i>Installing the receiver</i> on page 6). Wait at least 1 minute, then try turning the power on again. The temperature within the unit has exceeded the allowable value. Lower the volume level.
The receiver suddenly power off or ADVANCED MCACC flashes.	The power unit is damaged. Unplug the receiver from the wall and call a Pioneer authorized independent service company.
Display blinks 12V TRG ERR .	An error has arisen in the 12 V trigger jacks. Reconnect accurately then turn the power back on.

No sound

Symptom	Remedy
No sound is output when an input function is selected.	Check the volume, mute setting (press MUTE) and speaker setting (press SPEAKERS).
No sound is output from the front speakers.	Make sure the correct input function is selected. Check that the MCACC setup microphone is disconnected. Make sure the correct input signal is selected (press SIGNAL SEL). Note that when Fixed PCM ON is selected, you won't be able to hear any other signal format (see <i>Setting the Audio options</i> on page 50). Check that the source component is connected properly (see <i>Connecting your equipment</i> on page 11). Check that the speakers are connected properly (see <i>Connecting the speakers</i> on page 13).
No sound from the surround or center speakers.	Check that the Stereo listening mode or the Front Stage Surround Advance mode isn't selected; select one of the surround listening modes (see <i>Enjoying various types of playback using the listening modes</i> on page 37). Check that the surround/center speakers are not set to NO (see <i>Speaker Setting</i> on page 69). Check the channel level settings (see <i>Channel Level</i> on page 70). Check the speaker connections (see <i>Connecting the speakers</i> on page 13).

Symptom	Remedy
No sound from surround back speakers.	<p>Check that the surround back speakers are set to LARGE or SMALL, and the surround speakers are not set to NO (see <i>Speaker Setting</i> on page 69).</p> <p>Check the speaker connections (see <i>Connecting the speakers</i> on page 13). If only one surround back speaker is connected, make sure it's connected to the left channel speaker terminal.</p> <p>Surround back speakers will not play while the Speaker System is set to Speaker B and audio is being played through speaker B.</p> <p>When Speaker System is set to Normal(SB/FH) or Normal(SB/FW) and SP: FH ON or SP: FW ON is selected with the SPEAKERS button, no sound will be output from the surround back speakers. Select SP: SB/FH ON, SP: SB/FW ON or SP: SB ON (see <i>Switching the speaker terminals</i> on page 53).</p>
No sound from front height or front wide speakers.	<p>Check that the front height or front wide speakers are set to LARGE or SMALL, and the surround speakers are not set to NO (see <i>Speaker Setting</i> on page 69).</p> <p>When Speaker System is set to Normal(SB/FH) or Normal(SB/FW) and SP: SB ON is selected with the SPEAKERS button, no sound will be output from the front height or front wide speakers. Select SP: SB/FH ON, SP: SB/FW ON, SP: FH ON or SP: FW ON (see <i>Switching the speaker terminals</i> on page 53).</p> <p>Check the speaker connections (see <i>Connecting the speakers</i> on page 13).</p>
No sound from subwoofer.	<p>Check that the subwoofer is connected properly, switched on and the volume turned up.</p> <p>If your subwoofer has a sleep function, make sure it is switched off.</p> <p>Make sure that the Subwoofer setting is YES or PLUS (see <i>Speaker Setting</i> on page 69).</p> <p>The crossover frequency may be set too low; try setting it higher to match the characteristics of your other speakers (see <i>Speaker Setting</i> on page 69).</p> <p>If there is very little low frequency information in the source material, change your speaker settings to Front: SMALL / Subwoofer: YES, or Front: LARGE / Subwoofer: PLUS (see <i>Speaker Setting</i> on page 69).</p> <p>Check that the LFE channel is not set to OFF, or to a very quiet setting (see <i>Setting the Audio options</i> on page 50).</p> <p>Check the speaker level settings (see <i>Channel Level</i> on page 70).</p>
No sound from one speaker.	<p>Check the speaker connection (see <i>Connecting the speakers</i> on page 13).</p> <p>Check the speaker level settings (see <i>Channel Level</i> on page 70).</p> <p>Check that the speaker hasn't been set to NO (see <i>Speaker Setting</i> on page 69).</p> <p>The channel may not be recorded in the source. By using one of the advanced effect listening modes, you may be able to create the missing channel (see <i>Enjoying various types of playback using the listening modes</i> on page 37).</p>

Symptom	Remedy
Sound is produced from analog components, but not from digital ones (DVD, LD, CD, etc.).	<p>Check that the input signal type is set to DIGITAL (see <i>Choosing the input signal</i> on page 39).</p> <p>Make sure that the digital input is assigned correctly for the input jack the component is connected to (see <i>The Input Setup menu</i> on page 28).</p> <p>Check the digital output settings on the source component.</p> <p>If the source component has a digital volume control, make sure this is not turned down.</p>
No sound is output or a noise is output when Dolby Digital/DTS software is played back.	<p>Check that your BD or DVD player is compatible with Dolby Digital/DTS discs.</p> <p>Check the digital output settings or the HDMI audio output settings of your BD or DVD player. Make sure that the DTS signal output is set to On.</p> <p>If the source component has a digital volume control, make sure this is not turned down.</p>
No sound when using the Home Menu.	<p>If the HDMI input function is selected, sound is muted until exiting the Home Menu.</p>
Other audio problems	
Symptom	Remedy
Speaker switching sound (clicking sound) is heard from receiver during playback.	<p>Depending on the listening mode, the front height (or front wide) and surround back speakers may switch automatically in function of changes in the input audio. A speaker switching sound (clicking sound) will be heard from the receiver at this time. If this sound bothers you, we recommend to change the speaker terminal option (see <i>Switching the speaker terminals</i> on page 53).</p>
Broadcast stations cannot be selected automatically, or there is considerable noise in radio broadcasts.	<p>Fully extend the FM wire antenna, adjust the position for best reception and secure to a wall, etc.</p> <p>Use an outdoor antenna for better reception (see page 21).</p> <p>Adjust the position and direction of the AM antenna.</p> <p>Noise may be caused by interference from other equipment, such as a fluorescent light, motor, etc. Switch off or move the other equipment, or move the AM antenna.</p>
Noise is output when scanning a DTS CD.	<p>This is not a malfunction of the receiver. The scan function of your player alters the digital information, making it unreadable, resulting in noise being output. Lower the volume when scanning.</p>
When playing a DTS format LD there is audible noise on the soundtrack.	<p>Make sure that the input signal type is set to DIGITAL (see <i>Choosing the input signal</i> on page 39).</p>
Can't record audio.	<p>You can only make a digital recording from a digital source, and an analog recording from an analog source.</p> <p>For digital sources, make sure that what you're recording isn't copy protected.</p>
Subwoofer output is very low.	<p>To route more signal to the subwoofer, set it to PLUS or set the front speakers to SMALL (see <i>Speaker Setting</i> on page 69).</p>

Symptom	Remedy
Everything seems to be set up correctly, but the playback sound is odd.	The speakers may be out of phase. Check that the positive/negative speaker terminals on the receiver are matched with the corresponding terminals on the speakers (see <i>Connecting the speakers</i> on page 13).
The Phase Control feature doesn't seem to have an audible effect.	If applicable, check that the lowpass filter switch on your subwoofer is off, or the lowpass cutoff is set to the highest frequency setting. If there is a PHASE setting on your subwoofer, set it to 0° (or depending on the subwoofer, the setting where you think it has the best overall effect on the sound). Make sure the speaker distance setting is correct for all speakers (see <i>Speaker Distance</i> on page 70).
VSX-53 only: Full Band Phase Control cannot be selected.	Perform Full Auto MCACC measurements (see <i>Automatically conducting optimum sound tuning (Full Auto MCACC)</i> on page 26). Full Band Phase Control automatically turns on once measurements are completed.
Noise or hum can be heard even when there is no sound being input.	Check that personal computers or other digital components connected to the same power source are not causing interference.
Can't select some Input functions by the INPUT SELECTOR on the front panel or the INPUT SELECT button on the remote control.	Check the Input Skip settings in the Input Setup menu (see <i>The Input Setup menu</i> on page 28). Check the HDMI Input assignment in the Input Setup menu then try OFF (see <i>The Input Setup menu</i> on page 28).
There seems to be a time lag between the speakers and the output of the subwoofer.	See <i>Automatically conducting optimum sound tuning (Full Auto MCACC)</i> on page 26 to set up your system again using MCACC (this will automatically compensate for a delay in the subwoofer output).
The maximum volume available (shown in the front panel display) is lower than the +12dB maximum.	Check that the Volume Limit is set to OFF (see <i>Volume Setup</i> on page 74).
Certain listening modes or HOME MENU items cannot be selected.	When Operation Mode is set to Basic , the Pioneer-recommended settings are made and not all of the functions can be used. To use all of the functions without restrictions, set Operation Mode to Expert (see <i>Operation Mode Setup</i> on page 28).

ADAPTER PORT terminal

Symptom	Remedy
The Bluetooth wireless technology device cannot be connected or operated. Sound from the Bluetooth wireless technology device is not emitted or the sound is interrupted.	Check that no object that emits electromagnetic waves in the 2.4 GHz band (microwave oven, wireless LAN device or Bluetooth wireless technology apparatus) is near the unit. If such an object is near the unit, set the unit far from it. Or, stop using the object emitting the electromagnetic waves. Check that the Bluetooth wireless technology device is not too far from the unit and that obstructions are not set between the Bluetooth wireless technology device and the unit. Set the Bluetooth wireless technology device and the unit so that the distance between them is less than about 10 m (33 ft.) and no obstructions exist between them. Check that the Bluetooth ADAPTER and the ADAPTER PORT of the unit are correctly connected. The Bluetooth wireless technology device may not be set to the communication mode supporting the Bluetooth wireless technology. Check the setting of the Bluetooth wireless technology device. Check that pairing is correct. The pairing setting was deleted from this unit or the Bluetooth wireless technology device. Reset the pairing. Check that the profile is correct. Use a Bluetooth wireless technology device that supports A2DP profile and AVRCP profile.

Video

Symptom	Remedy
No image is output when an input is selected.	Check the video connections of the source component. For HDMI, or when digital video conversion is set to OFF and a TV and another component are connected with different cords (in <i>Setting the Video options</i> on page 52), you must connect your TV to this receiver using the same type of video cable as you used to connect your video component. Make sure the input assignment is correct for components connected using component video or HDMI cables (see <i>The Input Setup menu</i> on page 28). Check the video output settings of the source component. Check that the video input you selected on your TV is correct. Some components (such as video game units) have resolutions that may not be converted. If adjusting this receiver's Resolution setting (in <i>Setting the Video options</i> on page 52) and/or the resolution settings on your component or display doesn't work, try switching Digital Video Conversion (in <i>Setting the Video options</i> on page 52) to OFF .
Can't record video.	Check that the source is not copy-protected. The video converter is not available when making recordings. Check that the same type of video cable is used for connecting both the recorder and the video source (the one you want to record) to this receiver.

Symptom	Remedy
Noisy, intermittent, or distorted picture.	Sometimes a video deck may output a noisy video signal (during scanning, for example), or the video quality may just be poor (with some video game units, for example). The picture quality may also depend on the settings, etc. of your display device. Switch off the video converter and reconnect the source and display device using the same type of connection (component or composite), then start playback again.
Video signals are not output from the component terminal.	When a monitor only compatible with resolutions of 480i is connected to the component terminal and another monitor is connected to the HDMI terminal, the video signals may not be output to the monitor connected to the component terminal. If this happens, do the following: — Turn off the power of the monitor connected to the HDMI terminal. — Change the VIDEO PARAMETER menu RES setting (see <i>Setting the Video options</i> on page 52). — Video signals from the HDMI terminal cannot be output to the component terminals. Input the video signals from the player or other source to the composite or component terminals. When using the component terminal, assign it at Input Setup (see <i>The Input Setup menu</i> on page 28).
The picture's movement is unnatural.	When Resolution under VIDEO PARAMETER is set to 1080/24p, the picture may not be displayed properly for some source materials. In this case, set the resolution to something other than 1080/24p (page 52).

Settings

Symptom	Remedy
The Auto MCACC Setup continually shows an error.	The ambient noise level may be too high. Keep the noise level in the room as low as possible (see also <i>Problems when using the Auto MCACC Setup</i> on page 27). If the noise level cannot be kept low enough, you will have to set up the surround sound manually (page 69). When using only one surround back speaker, connect it to the SURROUND BACK L (Single) terminals. To use a 5.1-channel speaker set, use the surround speakers for the surround channel, not the surround back channel. Make sure there are no obstacles between the speakers and the microphone. If Reverse Phase is displayed, try the following: — The speaker's wiring (+ and -) may be inverted. Check the speaker connections. — Depending on the type of speakers and their installation conditions, Reverse Phase may be displayed even if the speakers are properly connected. If this happens, select GO NEXT and continue. — If the speaker is not pointed to the microphone (listening position) or when using speakers that affect the phase (dipole speakers, reflective speakers, etc.), it may not be possible to properly identify the polarity.

Symptom	Remedy
After using the Auto MCACC Setup, the speaker size setting is incorrect.	There may have been some low frequency noise in the room from an air-conditioner, motor, etc. Switch off all other appliances in the room and use Auto MCACC Setup again. Depending on a number of factors (bass reproduction capabilities of the speakers, room size, speaker placement, etc.) this may occur in some cases. Change the speaker setting manually in <i>Speaker Setting</i> on page 69, and use the ALL (Keep SP System) option for the Auto MCACC menu in <i>Automatic MCACC (Expert)</i> on page 62 if this is a recurring problem.
Can't adjust the Fine Speaker Distance setting properly.	Check that the speakers are all in phase (make sure the positive (+) and negative (-) terminals are matched up properly).
The display shows KEY LOCK ON when you try to make settings.	With the receiver in standby, press STANDBY/ON for about 10 seconds while holding down SPEAKERS to disable the key lock.
Most recent settings have been erased.	The power cord was disconnected from the wall while adjusting this setting. Settings are only stored if all the zones are turned off. Turn off all the zones before unplugging the power cord.
The various system settings are not stored.	Do not pull out the power cord while conducting the settings. (The settings will be stored when both the main zone and sub zone turn off. Turn off all zones before pulling out the power cord.)
Certain listening modes or HOME MENU items cannot be selected.	When Operation Mode is set to Basic , the Pioneer-recommended settings are made and not all of the functions can be used. To use all of the functions without restrictions, set Operation Mode to Expert (see <i>Operation Mode Setup</i> on page 28).

Professional Calibration EQ graphical output

Symptom	Remedy
The reverb characteristics graph after EQ calibration does not appear entirely flat.	There are cases where the graph does not appear flat (even when selecting ALL CH ADJ in the Auto MCACC Setup) due to adjustments made to compensate for room characteristics to achieve optimal sound. Areas of the graph may appear identical (before and after) when there is little or no adjustment needed. The graph may appear to have shifted vertically when comparing before and after measurements.
EQ adjustments made using the Manual MCACC setup do not appear to change the reverb characteristics graph after EQ calibration.	Despite level adjustments being made, the filters used for analysis may not display these adjustments in the reverb characteristics graph after EQ calibration. However, these adjustments are taken into account by the filters dedicated to overall system calibration.

Symptom	Remedy
Lower frequency response curves do not seem to have been calibrated for SMALL speakers.	Low frequencies used in bass management (the subwoofer channel) will not change for speakers that have been specified as SMALL in the configuration, or do not output these frequencies. Calibration is performed, but due to your speakers' low frequency limitations, no measurable sound is output for display.

Display

Symptom	Remedy
The display is dark or off.	Press DIMMER repeatedly to select a different brightness.
You can't get DIGITAL to display when using SIGNAL SEL .	Check the digital connections and make sure that the digital inputs are assigned correctly (see <i>The Input Setup menu</i> on page 28).
⏏ DIGITAL or DTS does not light when playing Dolby/DTS software.	These indicators do not light if playback is paused. Check the playback (especially the digital output) settings of the source component.
When playing Dolby Digital or DTS sources, the receiver's format indicators do not light.	Check that the player is connected using a digital connection. Make sure that the receiver is set to AUTO or DIGITAL (see <i>Choosing the input signal</i> on page 39). Check that the player isn't set up so that Dolby Digital and DTS sources are converted to PCM. Ensure that if there are several audio tracks on the disc, the Dolby Digital or DTS is selected.
When playing certain discs, none of the receiver's format indicators light.	The disc may not contain 5.1/6.1 channel material. Check the disc packaging for more on what audio tracks are recorded on the disc.
When playing a disc with the listening mode set to Auto Surround or ALC, ⏏ Pro Logic II or DTS Neo:6 appear on the receiver.	Make sure that the receiver is set to AUTO or DIGITAL (see <i>Choosing the input signal</i> on page 39). If a two channel soundtrack is currently playing (including Dolby Surround encoded), then this is not a malfunction. Check the disc packaging for details about the audio tracks available.
During playback of DVD-Audio, the display shows PCM .	This will occur when playing DVD-Audio material over the HDMI connection. This is not a malfunction.
The power turns off automatically and some indicator flashes, or some indicator flashes and the power does not turn on.	See the Power section (page 76).

Remote control

Symptom	Remedy
Cannot be remote controlled.	Set the remote control unit's remote control mode so that it matches the setting on the main unit (see <i>Operating multiple receivers</i> on page 56). Check whether the receiver's remote control mode is properly set (see <i>Remote Control Mode Setup</i> on page 74). Try replacing the batteries in the remote control (see <i>Loading the batteries</i> on page 6). Be sure to operate within 7 m (23 ft.) and a 30° angle of the remote sensor on the front panel (see <i>Operating range of remote control unit</i> on page 7). Check that there are no obstacles between the receiver and the remote control. Make sure that there is no fluorescent or other strong light shining on to the remote sensor. Check the connections of the CONTROL IN jacks (see <i>Operating other Pioneer components with this unit's sensor</i> on page 24).
Other components can't be operated with the system remote.	If the battery ran down, the preset codes may have been cleared. Re-enter the preset codes. The preset code may be incorrect. Redo the procedure for entering preset codes. When commands from the remote control units of other devices are registered using the learning function, in some cases they may not be learned properly. In this case, register the commands again using the learning function (see page 57). If they still do not work, they may be in a special format that cannot be registered on this receiver's remote control. Operate the device using another remote control.

HDMI

Symptom	Remedy
The HDMI indicator blinks continuously.	Check all the points below.

Symptom	Remedy
No picture or sound.	<p>This receiver is HDCP-compatible. Check that the components you are connecting are also HDCP-compatible. If they are not, please connect them using the component or composite video jacks.</p> <p>Depending on the connected source component, it's possible that it will not work with this receiver (even if it is HDCP-compatible). In this case, connect using the component or composite video jacks between source and receiver.</p> <p>If the problem still persists when connecting your HDMI component directly to your monitor, please consult the component or monitor manual or contact the manufacturer for support.</p> <p>If video images do not appear on your TV, try adjusting the resolution, Deep Color or other setting for your component.</p> <p>While analog video signals are being output over HDMI, use a separate connection for audio output.</p> <p>To output signals in Deep Color, use an HDMI cable (High Speed HDMI® Cable) to connect this receiver to a component or TV with the Deep Color feature.</p>
No picture.	<p>Try changing the Resolution setting (in <i>Setting the Video options</i> on page 52).</p>
No sound, or sound suddenly ceases.	<p>Check that the HDMI Audio setting is set to AMP (<i>Setting the Audio options</i> on page 50).</p> <p>If the component is a DVI device, use a separate connection for the audio.</p> <p>If analog video is being output over HDMI, please use a separate connection for the audio.</p> <p>Check the audio output settings of the source component.</p> <p>HDMI format digital audio transmissions require a longer time to be recognized. Due to this, interruption in the audio may occur when switching between audio formats or beginning playback.</p> <p>Turning on/off the device connected to this unit's HDMI OUT terminal during playback, or disconnecting/connecting the HDMI cable during playback, may cause noise or interrupted audio.</p>
Noisy or distorted picture.	<p>Sometimes a video deck may output a noisy video signal (during scanning, for example), or the video quality may just be poor (with some video game units, for example). The picture quality may also depend on the settings, etc. of your display device. Switch off the video converter and reconnect the source and display device using the same type of connection (component or composite), then start playback again.</p> <p>If the problem still persists when connecting your HDMI component directly to your monitor, please consult the component or monitor manual or contact the manufacturer for support.</p>

Symptom	Remedy
HDCP ERROR shows in the display.	<p>Check whether or not the connected component is compatible with HDCP. If it is not compatible with HDCP, reconnect the source device using a different type of connection (component or composite). Some components that are compatible with HDCP still cause this message to be displayed, but so long as there is no problem with displaying video, this is not a malfunction.</p>
When Control with HDMI is set to ON , the TV/SAT input's HDMI Input assignment is canceled.	<p>Even when Control with HDMI is set to ON, the HDMI input is assigned for the BD, DVD, DVR/BDR and VIDEO inputs regardless of the Control with HDMI setting, so use these terminals.</p>
Synchronized operation not possible using Control with HDMI function.	<p>Check the HDMI connections.</p> <p>The cable may be damaged.</p> <p>Select ON for the Control with HDMI setting (see <i>HDMI Setup</i> on page 47).</p> <p>Select ALL for the Control Mode with HDMI setting (see <i>HDMI Setup</i> on page 47).</p> <p>Turn the TV's power on before turning on this receiver's power.</p> <p>Set the TV side Control with HDMI setting to on (see TV's operating instructions).</p> <p><i>VX-53 only:</i> Connect the TV to the HDMI OUT 1 terminal and set the HDMI output to HDMI OUT 1. Then turn on first the TV's power, then this receiver's power.</p>

Troubleshooting 2

AVNavigator

Symptom	Causes	Remedy
AVNavigator does not interact well with the receiver.	The receiver's power is not turned on.	Turn the receiver's power on. (Wait about 60 seconds after the power turns on for network functions to start.) After this, press Detection in AVNavigator to redetect the receiver.
	The receiver or computer is not connected to the LAN.	Connect a LAN cable to the receiver or computer (page 22). After this, press Detection in AVNavigator to redetect the receiver.
	The router's power is off.	Turn the router's power on. After the router is fully started up, press Detection in AVNavigator to redetect the receiver.
	AVNavigator's network settings are not correct.	If your router does not support DHCP, the receiver's IP address must be set in AVNavigator. First set the IP address on the receiver, then set the same address in AVNavigator (page 71). After this, press Detection in AVNavigator to redetect the receiver.
	The receiver's port number setting has been changed.	Click Settings on the AVNavigator's function menu, select the IP Address tab and input the changed port number (one of the port numbers set on the receiver) (page 72). After this, press Detection in AVNavigator to redetect the receiver.
	Network connections could be restricted due to the computer's network settings, security settings, etc.	Check the computer's network settings, security settings, etc. After this, press Detection in AVNavigator to redetect the receiver.
	When the operating instructions interactive mode is changed, the settings may not be transferred to the browser, causing AVNavigator to stop interacting.	Either refresh the page's display using the browser's refresh button or display a different page from the links so that the setting is transferred.

Symptom	Causes	Remedy
When the Wiring Navi, Interactive Manual, Glossary or Software Update is launched, a warning about security protection appears on the browser.	This is because of the browser's security function.	This is not a problem. Perform the operation to authorize the blocked contents.
AVNavigator cannot be installed.	An error message may appear if there are not enough system resources available. Installation of AVNavigator may fail because of incompatibilities with other applications.	Re-start the PC, then start the installer (AVNV_XXX_xxx.exe) with no other applications active. Try the following, in the order indicated. 1. If there are any other applications active, exit the other applications and try starting the installer (AVNV_XXX_xxx.exe) again. 2. If that does not work, try restarting your PC, and starting the installer (AVNV_XXX_xxx.exe) with no other applications active.
Software updating does not operate well.	There may be a problem with your Internet Service Provider's network.	Contact your contracted provider.

USB interface

Symptoms	Causes	Remedies
The folders/files stored on a USB memory device are not displayed.	The folders/files are currently stored in a region other than the FAT (File Allocation Table) region. The number of levels in a folder is more than 8. There are more than 30 000 folders/files stored in a USB memory device. The audio files are copyrighted.	Store the folders/files in the FAT region. Limit the maximum number of levels in a folder to 8 (page 31). Limit the maximum number of folders/files stored in a USB memory device to 30 000 (page 31). Copyrighted audio files stored on a USB memory device cannot be played back (page 31).

Symptoms	Causes	Remedies
A USB memory device is not recognized.	The USB memory device does not support the mass storage class specifications.	Try using a USB memory device compatible with the mass storage class specifications. Note that there are cases where even the audio files stored on a USB memory device compatible with the mass storage class specifications are not played back on this receiver (page 31).
		Connect the USB memory device and switch on this receiver (page 23).
A USB hub is currently being used.	This receiver does not support USB hubs (page 31).	
	This receiver recognizes the USB memory device as a fraud.	Switch off and on again this receiver.
A USB memory device is connected and displayed, but the audio files stored on the USB memory device cannot be played back.	Some formats of USB memory devices, including FAT 12, NTFS, and HFS, cannot be played back on this receiver.	Check whether the format of your USB memory device is either FAT 16 or FAT 32. Note that the FAT 12, NTFS, and HFS formats cannot be played back on this receiver (page 31).
	The file format cannot be properly played back on this receiver.	See the list of file formats that can be played back on this receiver (page 32).
Cannot detect USB keyboard.	The USB keyboard is routed through a USB hub.	This receiver is not compatible with USB hubs. Plug the keyboard directly into the receiver.
	A PS2 keyboard is routed through a PS2/USB connector.	PS2 keyboards cannot be used with this receiver, even if routed through a PS2/USB connector. Use a USB keyboard.
	Keyboard is not a USB HID Class device.	Some devices will not be detected. Use a USB HID Class keyboard.
Cannot enter correct text using the USB keyboard.	Keyboard is not US-international layout keyboard.	Use a US-international layout keyboard. NB: Some characters cannot be entered.

HOME MEDIA GALLERY

Symptoms	Causes	Remedies
Cannot access the network.	The LAN cable is not firmly connected.	Firmly connect the LAN cable (page 22).
	The router is not switched on.	Switch on the router.
	Internet security software is currently installed in the connected component.	There are cases where a component with Internet security software installed cannot be accessed.
	The audio component on the network which has been switched off is switched on.	Switch on the audio component on the network before switching on this receiver.

Symptoms	Causes	Remedies
Playback does not start while "Connecting..." continues to be displayed.	The component is currently disconnected from this receiver or the power supply.	Check whether the component is properly connected to this receiver or the power supply.
The PC or Internet radio is not properly operated.	The corresponding IP address is not properly set.	Switch on the built-in DHCP server function of your router, or set up the network manually according to your network environment (page 71).
	The IP address is being automatically configured.	The automatic configuration process takes time. Please wait.
The audio files stored on components on the network, such as a PC, cannot be played back.	Windows Media Player 11 or Windows Media Player 12 is not currently installed on your PC.	Install Windows Media Player 11 or Windows Media Player 12 on your PC (page 41).
	Audio files were recorded in formats other than MP3, WAV (LPCM only), MPEG-4 AAC, FLAC, and WMA.	Play back audio files recorded in MP3, WAV (LPCM only), MPEG-4 AAC, FLAC, or WMA. Note that some audio files recorded in these formats may not be played back on this receiver.
	Audio files recorded in MPEG-4 AAC or FLAC are being played back on Windows Media Player 11 or Windows Media Player 12.	Audio files recorded in MPEG-4 AAC or FLAC cannot be played back on Windows Media Player 11 or Windows Media Player 12. Try using another server. Refer to the operation manual supplied with your server.
	The component connected to the network is not properly operated.	Check whether the component is affected by special circumstances or is in the sleep mode. Try rebooting the component if necessary.
	The component connected to the network does not permit file sharing.	Try changing the settings for the component connected to the network.
	The folder stored on the component connected to the network has been deleted or damaged.	Check the folder stored on the component connected to the network.
	Network connections could be restricted due to the computer's network settings, security settings, etc.	Check the computer's network settings, security settings, etc.
Cannot access the component connected to the network.	The component connected to the network is not properly set.	If the client is automatically authorized, you need to enter the corresponding information again. Check whether the connection status is set to "Do not authorize".
	There are no playable audio files on the component connected to the network.	Check the audio files stored on the component connected to the network.

Symptoms	Causes	Remedies
Audio playback is undesirably stopped or disturbed.	The audio file currently being played back was not recorded in a format playable on this receiver.	Check whether the audio file was recorded in a format supported by this receiver. Check whether the folder has been damaged or corrupted. Note that there are cases where even the audio files listed as playable on this receiver cannot be played back or displayed (page 45).
	The LAN cable is currently disconnected.	Connect the LAN cable properly (page 22).
	There is heavy traffic on the network with the Internet being accessed on the same network.	Use 100BASE-TX to access the components on the network.
	When in the DMR mode, depending on the external controller being used, playback may be interrupted when a volume operation is performed from the controller.	In this case, adjust the volume from the receiver or remote control.
	There is a connection routed through a wireless LAN on the same network.	There may be a shortage of bandwidth on the 2.4 GHz band used by the wireless LAN. Make wired LAN connections not routed through a wireless LAN. Install away from any devices emitting electromagnetic waves on the 2.4 GHz band (microwave ovens, game consoles, etc.). If this does not solve the problem, stop using other devices that emit electromagnetic waves.
Cannot access Windows Media Player 11 or Windows Media Player 12.	<i>In case of Windows Media Player 11:</i> You are currently logged onto the domain through your PC with Windows XP or Windows Vista installed. <i>In case of Windows Media Player 12:</i> You are currently logged onto the domain through your PC with Windows 7 installed.	Instead of logging onto the domain, log onto the local machine (page 42).

Symptoms	Causes	Remedies
Cannot listen to Internet radio stations.	The firewall settings for components on the network are currently in operation. You are currently disconnected from the Internet.	Check the firewall settings for components on the network. Check the connection settings for components on the network, and consult with your network service provider if necessary (page 71).
	The broadcasts from an Internet radio station are stopped or interrupted.	There are cases where you cannot listen to some Internet radio stations even when they are listed in the list of Internet radio stations on this receiver (page 42).
The Home Media Gallery cannot be operated with the buttons on the remote control.	The remote control is not currently set to the Home Media Gallery mode.	Press HMG to set the remote control to the Home Media Gallery mode (page 42).

SIRIUS radio messages

Status messages	Causes	Remedy
Antenna Error	The SIRIUS antenna is not properly connected.	Check that the antenna cable is attached securely.
Check Sirius Tuner	The SiriusConnect™ tuner is not properly connected.	Check that the 8 pin mini DIN cable and AC Adapter are attached securely.
Acquiring Signal	The SIRIUS signal is too weak at the current location.	Check for antenna obstructions and reposition the SIRIUS antenna to get better signal reception. Use the Antenna Aiming option to optimize the antenna position.
Subscription Updating	Unit is updating subscription.	Wait until the encryption code has been updated.
Updating Channels	Unit is updating channels.	Wait until the encryption code has been updated.
Invalid Channel	Selected channel is not available/ does not exist.	Select another channel.
Firmware Updating	The SiriusConnect™ tuner's firmware is being updated.	Wait for updating to finish.

Troubleshooting of wireless LAN

Network cannot be accessed via wireless LAN.

Wireless LAN converter's power is not on. (Wireless LAN converter's "Power", "WPS" and "Wireless" indicators are not all lit.)

- Check that the USB cable connecting the wireless LAN converter to the receiver's **DC OUTPUT for WIRELESS LAN** terminal is properly connected.

WLAN POW ERR is displayed on the receiver's display window.

- There is a problem with the wireless LAN converter's power supply. Turn the receiver's power off, then disconnect the USB cable, reconnect the USB cable and turn the receiver's power back on.
- If **WLAN POW ERR** is still displayed after repeating the above procedure several times, there is a problem with the receiver or the USB cable. Unplug the receiver from the wall and call a Pioneer authorized independent service company.

The LAN cable is not firmly connected.

- Firmly connect the LAN cable (page 23).

Wireless LAN converter and base unit (wireless LAN router, etc.) are too far apart or there is an obstacle between them.

- Improve the wireless LAN environment by moving the wireless LAN converter and base unit closer together, etc.

There is a microwave oven or other device generating electromagnetic waves near the wireless LAN environment.

- Use the system in a place away from microwave ovens or others device generating electromagnetic waves.
- Avoid using devices generating electromagnetic waves as much as possible when using the system with the wireless LAN.

Multiple wireless LAN converters are connected to the wireless LAN router.

- When connecting multiple wireless LAN converters, their IP addresses must be changed. For example, if the wireless LAN router's IP address is "192.168.1.1", set the first wireless LAN converter's IP address to "192.168.1.249", the second wireless LAN converter's IP address to "192.168.1.248", using values between 2 and 249 (such as "249" and "248") that are not assigned to other wireless LAN converters or to other devices.

Wireless LAN connections cannot be established between the wireless LAN converter and base unit (wireless LAN router, etc.).

- The wireless LAN converter must be set in order to establish wireless LAN connections. See *Wireless LAN Converter* on page 72 .

The wireless LAN converter is properly connected to the receiver and the wireless LAN converter's indicators are lit, but the wireless LAN converter cannot be set from the receiver (the settings screen cannot be displayed).

- If DHCP in the receiver's IP settings is set to OFF and the IP address has been set manually, the IP address set in the wireless LAN converter may not match.

In the receiver's IP settings, set DHCP to ON. After the setting is completed, turn the receiver's power off. Next, turn the receiver's power back on and check whether the wireless LAN converter's settings can be displayed with the receiver.

If the settings can be displayed, change the IP address settings of the receiver and wireless LAN converter as necessary.

The IP address settings of the receiver and wireless LAN converter do not match the settings of the wireless LAN router, etc.

- Check the IP address settings of the receiver and wireless LAN converter (including the DHCP setting).

If the receiver's DHCP setting is "ON", turn the receiver's power off, then turn the power back on.

Check that the IP addresses of the receiver and wireless LAN converter match the settings of the wireless LAN router, etc.

If the receiver's DHCP setting is "OFF", set an IP address matching the network of the base unit (wireless LAN router, etc.).

For example, if the wireless LAN router's IP address is "192.168.1.1", set the receiver's IP address to "192.168.1.XXX" (*1), the subnet mask to "255.255.255.0", the gateway and DNS to "192.168.1.1".

Next, set the wireless LAN converter's IP address to "192.168.1.249" (*2).

(*1) Set the "XXX" in "192.168.1.XXX" to a number between 2 and 248 that is not assigned to other devices.

(*2) Set the "249" in "192.168.1.249" to a number between 2 and 249 that is not assigned to other devices.

Try making the wireless LAN converter's advanced settings.

- The wireless LAN converter can be connected to a computer to make the advanced wireless LAN settings. For details, see the CD-ROM included for the wireless LAN converter. Check the settings of the wireless LAN router, etc., then change the settings of the wireless LAN converter.

Note, however, that making the advanced wireless LAN settings will not necessarily improve the wireless LAN environment. Be careful when changing the settings.

The access point is set to conceal the SSID.

- In this case, the SSID may not be displayed on the access point list screen. If not, set the SSID, etc., by making the wireless LAN converter settings on the receiver manually.

The access point's security settings use WEP 152-bit length code key or shared key authentication.

- The receiver does not support WEP 152-bit length code key or shared key authentication.

Network connections cannot be established even when the above measures are taken.

- Reset the wireless LAN converter. After this, redo the wireless LAN converter's settings. About resetting

1. Check that the wireless LAN converter's power is on.
2. Press the wireless LAN converter's reset button for at least 3 seconds.
3. Release the reset button.

When the wireless LAN converter is restarted, the resetting procedure is completed.

About status messages

Refer to the following information when you come up with a status message while operating the Home Media Gallery.

Status messages	Descriptions
STARTING H.M.G.	A component on the network, including a PC, is currently being connected. Wait for a while.
Connection Down	The selected category or Internet radio station cannot be accessed.
File Format Error	Cannot be played back for some reasons.
Track Not Found	The selected song has not been found anywhere on the network.
Server Error	The selected server cannot be accessed.
Server Disconnected	The server has been disconnected.
empty	There are no files stored in the selected folder.
Preset Not Stored	The selected Internet radio station is not currently registered and saved.
Out of Range	The value entered is beyond the permitted range of the network settings.
License Error	The license for the contents to be played back is invalid.
Item Already Exists	This is displayed when the file you have attempted to register in the Favorites folder has already been registered.
Favorite List Full	This is displayed when you have attempted to register a file in the Favorites folder but the Favorites folder is already full.

Speaker Setting Guide

In order to achieve an even better surround effect, it is important to accurately position the speakers and make their volume and tone characteristics uniform so as to finely focus the multi-channel sound.

The three major elements in positioning the speakers are **distance**, **angle** and **orientation** (the direction in which the speakers are pointing).

Distance: The distance of all the speakers should be equal.

Angle: The speakers should be horizontally symmetrical.

Orientation: The orientation should be horizontally symmetrical.

In most homes, however, it is not possible to achieve this environment. For the distance, on this receiver it is possible to automatically correct the speaker distance electrically to a precision of 0.5 inch using the Full Auto MCACC Setup function (page 26).

VSX-53 only: For the volume and sound quality as well, accurate sound field correction using the equalizer and speaker phase characteristic correction using the Full Band Phase Control function (page 39) together make it possible to achieve the ideal listening environment.

Step 1: Speaker layout and distance adjustment

Use speaker stands or the like to make sure the speakers are steady, and leave at least 10 cm (4 inches) from the surrounding walls. Position the speakers attentively so that the speakers on the left and right are at equal angles from the listening position (center of the adjustments). (We recommend using cords, etc., when adjusting the layout.) Ideally all the speakers should be equidistant from the listening position.



Note

- If the speakers cannot be set at equal distances (on a circle), use the Auto MCACC Setup speaker distance correction and Fine Speaker Distance functions to make them equalize the distance artificially.

Step 2: Adjusting the speaker height

Adjust the heights (angles) of the different speakers.

Adjust so that the front speaker units reproducing mid- and high frequencies is roughly at the height of the ears.

If the center speaker cannot be set at the same height as the front speakers, adjust its angle of elevation to point it to the listening position. Set surround speaker 1 so that it is not under the height of the ears.

Step 3: Adjusting the speaker orientation

If the left and right speakers are not pointing in the same direction, the tone will not be the same on the right and left, and as a result the sound field will not be reproduced properly. However, if all the speakers are pointed towards the listening position, the sound field will seem cramped. Testing by the Pioneer Multi-channel Research Group has shown that a good sense of sound positioning can be achieved by pointing all the speakers towards an area 30 cm to 80 cm (12 inches to 31 inches) behind the listening position (between the surround speakers and the listening position). However, the sense of sound positioning can differ according to the conditions in the room and the speakers being used. In smaller environments in particular (when the front speakers are close to the listening position), with this method the speakers will be pointed

too inward. We suggest you use this example of installation as reference when trying out different installation methods.

Step 4: Positioning and adjusting the subwoofer

Placing the subwoofer between the center and front speakers makes even music sources sound more natural (if there is only one subwoofer, it doesn't matter if it is placed on the left or right side). The low bass sound output from the subwoofer is not directional and there is no need to adjust the height. Normally the subwoofer is placed on the floor. Put it in a position at which it will not cancel out the bass sound output from the other speakers. Also note that placing it near a wall may result in sympathetic vibrations with the building that could excessively amplify the bass sound.

If the subwoofer must be installed near a wall, place it at an angle so that it is not parallel to the wall surface. This can help reduce any sympathetic vibrations, but depending on the shape of the room this could result in standing waves. However, even if standing waves are generated, their influence on the sound quality can be prevented using the Auto MCACC's standing wave control function (page 64).

Step 5: Default settings with the Auto MCACC Setup (auto sound field correction) function

It is more effective to perform the Full Auto MCACC Setup (page 26) procedure once the adjustments described above have been completed.



Note

- The distance to the subwoofer may be slightly larger than the distance actually measured with a tape measure, etc. This is because this

distance is corrected for electric delay, and is not a problem.

Positional relationship between speakers and monitor

Position of front speakers and monitor

The front speakers should be as equidistant as possible to the monitor.

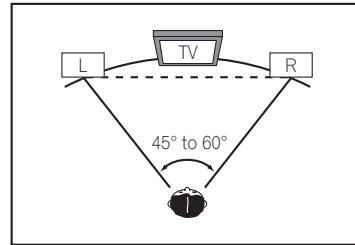

Position of center speaker and monitor

Since mostly dialogs are output from the center speaker, keeping the center speaker as close as possible to the screen makes the overall sound more natural. For TVs using Braun tubes, however, when installing the center speaker on the floor, adjust its angle of elevation to point it towards the listening position.

Installation on floor

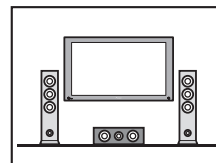

(Diagram as seen from the side)

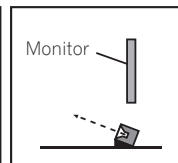

- If the center speaker is not of the shielded type, install it away from the TV.
- When installing the center speaker on top of the monitor, place it facing slightly downwards towards the listening position.

Important information regarding the HDMI connection

There are cases where you may not be able to route HDMI signals through this receiver (this depends on the HDMI-equipped component you are connecting-check with the manufacturer for HDMI compatibility information). If you aren't receiving HDMI signals properly through this receiver (from your component), please try one of the following configurations when connecting up.

Configuration A

Use component video cables to connect the video output of your HDMI-equipped component to the receiver's component video input. The receiver can then convert the analog component video signal to a digital HDMI signal for transmission to the display. For this configuration, use the most convenient connection (digital is recommended) for sending audio to the receiver. See the operating instructions for more on audio connections.



Note

- The picture quality will change slightly during conversion.

Configuration B

Connect your HDMI-equipped component directly to the display using an HDMI cable. Then use the most convenient connection (digital is recommended) for sending audio

to the receiver. See the operating instructions for more on audio connections. Set the display volume to minimum when using this configuration.



Note

- If your display only has one HDMI terminal, you can only receive HDMI video from the connected component.
- Depending on the component, audio output may be limited to the number of channels available from the connected display unit (for example audio output is reduced to 2 channels for a monitor with stereo audio limitations).
- If you want to switch the input function, you'll have to switch functions on both the receiver and your display unit.
- Since the sound is muted on the display when using the HDMI connection, you must adjust the volume on the display every time you switch input functions.

Cleaning the unit

- Use a polishing cloth or dry cloth to wipe off dust and dirt.
- When the surface is dirty, wipe with a soft cloth dipped in some neutral cleanser diluted five or six times with water, and wrung out well, and then wipe again with a dry cloth. Do not use furniture wax or cleansers.
- Never use thinners, benzene, insecticide sprays or other chemicals on or near this unit, since these will corrode the surface.

Surround sound formats

Below is a brief description of the main surround sound formats you'll find on BDs, DVDs, satellite, cable and terrestrial broadcasts, and video cassettes.

Dolby

The Dolby technologies are explained below. See <http://www.dolby.com> for more detailed information.



Manufactured under license from Dolby Laboratories. "Dolby", "Pro Logic", "Surround EX" and the double-D symbol are trademarks of Dolby Laboratories.

DTS

The DTS technologies are explained below. See <http://www.dts.com> for more detailed information.



Manufactured under license under U.S. Patent #'s: 5,451,942; 5,956,674; 5,974,380; 5,978,762; 6,226,616; 6,487,535; 7,212,872; 7,333,929; 7,392,195; 7,272,567 & other U.S. and worldwide patents issued & pending. DTS and the Symbol are registered trademarks, & DTS-HD, DTS-HD Master Audio, and the DTS logos are trademarks of DTS, Inc. Product includes software. © DTS, Inc. All Rights Reserved.

About THX

The THX technologies are explained below. See <http://www.thx.com> for more detailed information.



THX, the THX logo and Select2 Plus are trademarks of THX Ltd. which are registered in some jurisdictions. All rights reserved. All other trademarks are the property of their respective owners.

THX Cinema processing

THX is an exclusive set of standards and technologies established by THX Ltd. THX grew from George Lucas' personal desire to make your experience of the film soundtrack, in both movie theatres and in your home theatre, as faithful as possible to what the director intended. Movie soundtracks are mixed in special movie theatres called dubbing stages and are designed to be played back in movie theatres with similar equipment and conditions. This same soundtrack is then transferred directly onto Laserdisc, VHS tape, DVD, etc., and is not changed for playback in a small home

theatre environment. THX engineers developed patented technologies to accurately translate the sound from the movie theatre environment into the home, correcting the tonal and spatial errors that occur. On this product, when the THX indicator is on, THX features are automatically added in Cinema modes (e.g. THX Cinema, THX Surround EX).

Re-Equalization

The tonal balance of a film soundtrack will be excessively bright and harsh when played back over audio equipment in the home because film soundtracks were designed to be played back in large movie theaters using very different professional equipment. Re-Equalization restores the correct tonal balance for watching a movie soundtrack in a small home environment.

Timbre Matching

The human ear changes our perception of a sound depending on the direction from which the sound is coming. In a movie theatre, there is an array of surround speakers so that the surround information is all around you. In a home theatre, you use only two speakers located to the side of your head. The Timbre Matching feature filters the information going to the surround speakers so that they more closely match the tonal characteristics of the sound coming from the front speakers. This ensures seamless panning between the front and surround speakers.

Adaptive Decorrelation

In a movie theatre, a large number of surround speakers help create an enveloping surround sound experience, but in a home theatre there are usually only two speakers. This can make the surround speakers sound like headphones that lack spaciousness and envelopment. The surround sounds will also collapse into the

closest speaker as you move away from the middle seating position. Adaptive Decorrelation slightly changes one surround channel's time and phase relationship with respect to the other surround channel. This expands the listening position and creates-with only two speakers- the same spacious surround experience as in a movie theatre.

THX Select2 Plus

Before any home theatre component can be THX Select2 Plus certified, it must incorporate all the features above and also pass a rigorous series of quality and performance tests. Only then can a product feature the THX Select2 Plus logo, which is your guarantee that the Home Theatre products you purchase will give you superb performance for many years to come. THX Select2 Plus requirements cover every aspect of the product including pre-amplifier and power amplifier performance and operation, and hundreds of other parameters in both the digital and analog domain.

THX Surround EX

THX Surround EX - Dolby Digital Surround EX is a joint development of Dolby Laboratories and the THX Ltd. In a movie theater, film soundtracks that have been encoded with Dolby Digital Surround EX technology are able to reproduce an extra channel which has been added during the mixing of the program. This channel, called Surround Back, places sounds behind the listener in addition to the currently available front left, front center, front right, surround right, surround left and subwoofer channels. This additional channel provides the opportunity for more detailed imaging behind the listener and brings more depth, spacious ambience and sound localization than ever before. Movies that were created using the Dolby Digital Surround EX technology, when

released into the home consumer market may exhibit wording to that effect on the packaging. A list of movies created using this technology can be found on the Dolby web site at <http://www.dolby.com>.

Only amplifier and controller products bearing the THX Surround EX logo, when in the THX Surround EX mode, faithfully reproduce this new technology in the home.

This product may also engage the "THX Surround EX" mode during the playback of 5.1 channel material that is not Dolby Digital Surround EX encoded. In such case the information delivered to the Surround Back channel will be program dependent and may or may not be very pleasing depending on the particular soundtrack and the tastes of the individual listener.

Boundary Gain Compensation™

Depending on the listener's and the subwoofer's position, the listener may experience an excessive bass effect. This feature compensates for excessive bass resulting from a boundary gain effect. This feature is designed to operate when used with a subwoofer certified to THX Select2™ specifications.

THX Loudness Plus Description

THX Loudness Plus is a new volume control technology featured in THX Ultra2 Plus™ and THX Select2 Plus™ Certified amplifiers. With THX Loudness Plus, home theater audiences can now experience the rich details in a surround mix at any volume level. A consequence of turning the volume below Reference Level is that certain sound elements can be lost or perceived differently by the listener. THX Loudness Plus compensates for the tonal and spatial shifts that occur when the volume is reduced by intelligently adjusting ambient surround channel levels and frequency response. This

enables users to experience the true impact of soundtracks regardless of the volume setting. THX Loudness Plus is automatically applied when listening in any THX listening mode. The new THX Cinema, THX Music, and THX Games modes are tailored to apply the proper THX Loudness Plus settings for each type of content.

About iPod

Made for

 iPod  iPhone  iPad



"Made for iPod," "Made for iPhone," and "Made for iPad" mean that an electronic accessory has been designed to connect specifically to iPod, iPhone, or iPad, respectively, and has been certified by the developer to meet Apple performance standards. Apple is not responsible for the operation of this device or its compliance with safety and regulatory standards. Please note that the use of this accessory with iPod, iPhone, or iPad may affect wireless performance.

Apple, AirPlay, the AirPlay logo, iPad, iPhone, iPod, iPod shuffle, iPod nano, iPod classic, iPod touch, iTunes and Mac are trademarks of Apple Inc., registered in the U.S. and other countries.

About SIRIUS

SIRIUS
R E A D Y

SIRIUS
INTERNET RADIO

SIRIUS, XM and all related marks and logos are trademarks of Sirius XM Radio Inc. and its subsidiaries. All rights reserved. Service not available in Alaska and Hawaii.

About FLAC

FLAC Decoder

Copyright © 2000, 2001, 2002, 2003, 2004, 2005, 2006, 2007

Josh Coalson

Redistribution and use in source and binary forms, with or without modification, are permitted provided that the following conditions are met:

- Redistributions of source code must retain the above copyright notice, this list of conditions and the following disclaimer.
- Redistributions in binary form must reproduce the above copyright notice, this list of conditions and the following disclaimer in the documentation and/or other materials provided with the distribution.
- Neither the name of the Xiph.org Foundation nor the names of its contributors may be used to endorse or promote products derived from this software without specific prior written permission.

THIS SOFTWARE IS PROVIDED BY THE COPYRIGHT HOLDERS AND CONTRIBUTORS "AS IS" AND ANY EXPRESS OR IMPLIED WARRANTIES, INCLUDING, BUT NOT LIMITED TO, THE IMPLIED WARRANTIES OF MERCHANTABILITY AND FITNESS FOR A PARTICULAR PURPOSE ARE DISCLAIMED. IN NO EVENT SHALL THE FOUNDATION OR CONTRIBUTORS BE LIABLE FOR ANY DIRECT, INDIRECT, INCIDENTAL, SPECIAL, EXEMPLARY, OR CONSEQUENTIAL DAMAGES (INCLUDING, BUT NOT LIMITED TO, PROCUREMENT OF SUBSTITUTE GOODS OR SERVICES; LOSS OF USE, DATA, OR PROFITS; OR BUSINESS INTERRUPTION) HOWEVER CAUSED AND ON ANY THEORY OF LIABILITY, WHETHER IN CONTRACT, STRICT LIABILITY, OR TORT (INCLUDING NEGLIGENCE OR OTHERWISE) ARISING IN ANY WAY OUT OF THE USE OF THIS SOFTWARE, EVEN IF ADVISED OF THE POSSIBILITY OF SUCH DAMAGE.

Auto Surround, ALC and Stream Direct with different input signal formats

The following charts show what you will hear with different input signal formats, depending on the Stream Direct mode (see *Using Stream Direct* on page 38) you have selected.

Stereo (2 channel) signal formats

Input signal format	Auto Surround / ALC / DIRECT	PURE DIRECT
Surround Back speaker(s): Connected		
Dolby Digital Surround	ⓧ Pro Logic IIx MOVIE	ⓧ Pro Logic IIx MOVIE
DTS Surround	Neo:6 CINEMA	Neo:6 CINEMA
Other stereo sources	Stereo playback	Stereo playback
Analog sources	As above	ANALOG DIRECT (stereo)
PCM sources	As above	PCM DIRECT
DVD-A sources	As above	As above
SACD sources	As above	Stereo playback
Surround Back speaker(s): Not connected		
Dolby Digital Surround	ⓧ Pro Logic II MOVIE	ⓧ Pro Logic II MOVIE
DTS Surround	Neo:6 CINEMA	Neo:6 CINEMA
Other stereo sources	Stereo playback	Stereo playback
Analog sources	As above	ANALOG DIRECT (stereo)
PCM sources	As above	PCM DIRECT
DVD-A sources	As above	As above
SACD sources	As above	Stereo playback

Multichannel signal formats

Input signal format	Auto Surround / ALC	PURE DIRECT / DIRECT
Surround Back speaker(s): Connected		
Dolby Digital EX (6.1 channel flagged) Dolby TrueHD EX (6.1 channel flagged)	Dolby Digital EX ⓧ Pro Logic IIx MOVIE <a>	Dolby Digital EX ⓧ Pro Logic IIx MOVIE <a>
DTS-HD Master Audio ES (6.1 channel flagged)	DTS-ES (Matrix)	DTS-ES (Matrix)
DTS-ES (6.1 channel sources/6.1 channel flagged)	DTS-ES (Matrix/Discrete)	DTS-ES (Matrix/Discrete)
DTS sources (5.1 channel encoding)	Straight decoding	Straight decoding
DTS-HD sources	As above	As above
Other 5.1/6.1/7.1 channel sources	As above	As above
Surround Back speaker(s): Not connected		
DVD-A sources/Multi-ch PCM	Straight decoding	Straight decoding
SACD sources (5.1 channel encoding)	As above	As above
Other 5.1/6.1/7.1 channel sources	As above	As above

a Unavailable with only one surround back speaker connected.

Glossary

Audio formats/Decoding

Dolby

The Dolby technologies are explained below. See <http://www.dolby.com> for more detailed information.

Dolby Digital

Dolby Digital is a multichannel digital audio coding system widely used in cinemas, and in the home for DVD and digital broadcast soundtracks.

Dolby TrueHD

Dolby TrueHD is the lossless encoding technology developed for high-definition optical discs in the upcoming era.

Dolby Digital Plus

Dolby Digital Plus is the audio technology for all high-definition programming and media. It combines the efficiency to meet future broadcast demands with the power and flexibility to realize the full audio potential expected in the upcoming high-definition era.

Dolby Digital Surround EX

Dolby Digital Surround EX (the EX stands for EXtended) is an extension of Dolby Digital encoding whereby a surround back channel is matrixed into the surround left/right channels for 6.1 channel playback. This allows for compatibility with Dolby Digital 5.1 channel decoding, as well as for decoding using Dolby Digital EX.

Dolby Pro Logic IIx and Dolby Surround

Dolby Pro Logic IIx is an improved version of the Dolby Pro Logic II (and Dolby Pro Logic) decoding system.

Dolby Surround is an encoding system which embeds surround sound information within a stereo soundtrack, which a Dolby Pro Logic

decoder can then use for enhanced surround listening with greater sound detail.

Dolby Pro Logic IIz

Adding a pair of speakers above the front left and right speakers adds expressiveness in the vertical direction to the previous horizontally-oriented sound field. The height channel strengthens the sound field's sense of three-dimensionality and air, producing presence and expansion.

DTS

The DTS technologies are explained below. See <http://www.dts.com> for more detailed information.

DTS Digital Surround

DTS Digital Surround is a 5.1-channel audio coding system from DTS Inc. now widely used for DVD-Video, DVD-Audio, 5.1 music discs, digital broadcasts, and video games.

DTS-HD Master Audio

DTS-HD Master Audio is a technology that delivers master audio sources recorded in a professional studio to listeners without any loss of data, preserving audio quality.

DTS-HD High Resolution Audio

A high definition audio technology by which signals can be transferred over HDMI cables.

DTS-ES

DTS-ES (the ES stands for Extended Surround) is a decoder that is capable of decoding both DTS-ES Discrete 6.1 and DTS-ES Matrix 6.1 encoded sources.

DTS Neo:6

DTS Neo:6 can generate 7.1 channel surround sound from any matrixed stereo source (such as video or TV) and from 5.1 channel sources.

DTS Neural Surround

DTS Neural Surround can generate 7.1 channel surround sound from any matrixed stereo source (such as video or TV).

THX

The THX technologies are explained below. See <http://www.thx.com> for more detailed information.

THX Cinema

A mode for playing in a home theater environment the sound tracks of theater movies that have been recorded and edited for playback in large spaces such as movie theaters.

THX Music

A mode adjusted mainly for listening to music that has been mastered at a higher level than movie sound tracks.

THX Games

A mode for playing the sound of games with spatial fidelity. In many cases the sound is mixed in the same way as for movies, but this mode is meant for small environments rather than the large environments of theaters.

THX Surround EX

A mode using technology developed jointly by Dolby Laboratories and THX for creating a sound field behind the listeners.

THX Loudness Plus

A mode creating a rich, subtle surround sound field through optimal calibration of the volume and frequency response of the individual channels according to the volume level.

Decoding

A technology for converting digital signals that have been compressed upon recording by a digital signal processing circuit, etc., into the original signals. The term "decoding" (or "matrix decoding") is also used for the technology which converts 2-channel sound sources into multiple channels or expands 5.1-channel signals into 6.1 or 7.1 channels.

Calibrating the sound field/ Improving the sound quality

Phase Control

The Phase Control technology incorporated into this receiver's design provides coherent sound reproduction through the use of phase matching for an optimal sound image at your listening position.

Full Band Phase Control

V SX-53 only:

The Full Band Phase Control feature calibrates the frequency-phase characteristics of the speakers connected.

Virtual Surround Back

When you're not using surround back speakers, selecting this mode allows you to hear a virtual surround back channel through your surround speakers. You can choose to listen to sources with no surround back channel information.

Virtual Height

When you're not using front height speakers, selecting this mode allows you to hear a virtual front height channel through your front speakers.

Virtual Depth

When this mode is selected, the sound field expands virtually to behind the display, resulting in a sound field with the same depth as the 3D picture to achieve a better sense of presence.

Auto Sound Retriever

The Auto Sound Retriever feature employs DSP technology to restore sound pressure and smooth jagged artifacts left over after compression.

With some audio inputs, the Sound Retriever effect is automatically optimized based on the bitrate information of the contents that have been input to achieve high sound quality.

Sound Retriever Air

Sound Retriever Air compensates for reduced sound quality due to compression when sending *Bluetooth* signals.

PQLS

Jitterless high quality playback is possible by connecting a PQLS-compatible player with HDMI connections.

ALC (Auto Level Control)

In the Auto level control (ALC) mode, this receiver equalizes playback sound levels. Also, the low and high frequency sounds, dialogs, surround effects, etc., that are difficult to hear when the volume is low are adjusted to be optimal for the volume level. This mode is particularly optimum when listening at night.

Front Stage Surround Advance

With the Front Stage Surround Advance feature, you can enjoy seamless, natural surround sound effects using only the front speakers, without deteriorating the quality of the original sound.

MCACC

The Auto MCACC Setup provides a quick but accurate surround sound setup, which includes the advanced features of Professional Acoustic Calibration EQ.

HDMI

Control with HDMI function

Synchronized operations below with a **Control** with HDMI-compatible Pioneer TV or Blu-ray Disc player or with a component of another make that supports the **Control** with HDMI functions are possible when the component is connected to the receiver using an HDMI cable.

- The receiver's volume can be set and the sound can be muted using the TV's remote control.
- The receiver's input switches over automatically when the TV's input is

changed or a **Control** with HDMI-compatible component is played.

- The receiver's power is also set to standby, when the TV's power is set to standby.

ARC (Audio Return Channel)

When a TV supporting the HDMI ARC (Audio Return Channel) function is connected to the receiver, the sound of the TV can be input via the **HDMI OUT** terminal.

The sound of the TV can be input from the receiver's **HDMI OUT** terminal, so connection with the TV can be completed with a single HDMI cable.

Network function

AirPlay

This receiver supports AirPlay audio streaming from iPod touch (2nd, 3rd and 4th generations), iPhone 4, iPhone 3GS, iPad with iOS 4.2 or later, and iTunes 10.1 (Mac and PC) or later.

For more information, see the Apple website (<http://www.apple.com>).

DLNA

The Digital Living Network Alliance (DLNA) is a cross-industry organization of consumer electronics, computing industry and mobile device companies. Digital Living provides consumers with easy sharing of digital media through a wired or wireless network in the home.

vTuner

vTuner is a paid online database service that allows you to listen to radio and TV broadcasts on the Internet. vTuner lists thousands of stations from over 100 different countries around the globe. For more detail about vTuner, visit the following website:

<http://www.radio-pioneer.com>

"This product is protected by certain intellectual property rights of NEMS and BridgeCo. Use or distribution of such technology outside of this product is prohibited without a license

from NEMS and BridgeCo or an authorized subsidiary."

aacPlus

AAC decoder uses aacPlus developed by Coding Technologies. (www.codingtechnologies.com)



FLAC

FLAC (Free Lossless Audio Codec) is an audio format allows lossless codec. Audio is compressed in FLAC without any loss in quality. For more details about FLAC, visit the following website:

<http://flac.sourceforge.net/>

Windows Media

Windows Media is a multimedia framework for media creation and distribution for Microsoft Windows. Windows Media is either a registered trademark or trademark of Microsoft Corporation in the U.S. and/or other countries. Use an application licensed by Microsoft Corporation to author, distribute, or play Windows Media formatted content. Using an application unauthorized by Microsoft Corporation is subject to malfunction.

Windows Media Player 11/ Windows Media Player 12

Windows Media Player is software to deliver music, photos and movies from a Microsoft Windows computer to home stereo systems and TVs.

With this software, you can play back files stored on the PC through various devices wherever you like in your home.

This software can be downloaded from Microsoft's website.

- Windows Media Player 11 (for Windows XP or Windows Vista)
- Windows Media Player 12 (for Windows 7)

For more information check the official Microsoft website.

Windows Media DRM

Windows Media DRM is a DRM (Digital Rights Management) service for the Windows Media platform. It is designed to provide secure delivery of audio and/or video content over an IP network to a PC or other playback device in such a way that the distributor can control how that content is used. The WMDRM-protected content can only be played back on a component supporting the WMDRM service.

Router

A device for relaying data flowing on a network to another network. In homes, routers often also function as DHCP servers. Products with built-in wireless LAN access points are called "wireless LAN routers".

DHCP

Abbreviation of Dynamic Host Configuration Protocol. A protocol for automatically assigning such setting information as IP addresses within network connections. This offers convenience in that, when enabled, it allows network functions to be used simply by connecting the devices to the network.

Wireless LAN/Wi-Fi

"Wi-Fi" (Wireless Fidelity) is a trademark coined by the Wi-Fi Alliance trade association to increase recognition of wireless LAN standards. With the increase in the number of devices connected to computers in recent years, Wi-Fi offers the advantage of eliminating the complexity of making connections with LAN cables by using wireless connection. As a way of reassuring users, products that have passed interoperability tests carry the logo "Wi-Fi Certified" to indicate that compatibility is assured.

WPS

Abbreviation of Wi-Fi Protected Setup. A standard established by the Wi-Fi Alliance industry

group for a function allowing settings related to interconnection of WPS-compatible wireless LAN devices and encryption to be made with simple operations. There are a number of methods, including push-button configuration and PIN code configuration. This AV receiver supports both push-button configuration and PIN code configuration.

SSID

Abbreviation of Service Set Identifier. A wireless LAN access point identifier. Can be set as desired using up to 32 characters of English letters and numbers.

Bluetooth function

Bluetooth wireless technology

A short-range wireless communications standard for digital devices. Information is exchanged between devices several meters to several tens of meters apart using radio waves. It uses radio waves on the 2.4 GHz band which does not require applications for licenses or usage registration for applications conducting wireless exchange of digital information at relatively low speeds, such as computer mouses and keyboards, mobile phones, smartphones, text and audio information for PDAs, etc.

Pairing

"Pairing" must be done before you start playback of *Bluetooth* wireless technology content using the *Bluetooth* ADAPTER. Make sure to perform pairing the first time you operate the system or any time pairing data is cleared. The pairing step is necessary to register the *Bluetooth* wireless technology device to enable *Bluetooth* communications. For more details, see also the operating instructions of your *Bluetooth* wireless technology device.

- Pairing is required when you first use the *Bluetooth* wireless technology device and *Bluetooth* ADAPTER.

- To enable *Bluetooth* communication, pairing should be done with both your system and *Bluetooth* wireless technology device.

Receiver function

Operation Mode

This receiver is equipped with a great number of functions and settings. The Operation Mode feature is provided for users who find it difficult to master all these functions and settings.

Features index

Operation Mode

See *Operation Mode Setup* on page 28 .

AVNavigator

See *About using AVNavigator (included CD-ROM)* on page 7 .

Full Auto MCACC

See *Automatically conducting optimum sound tuning (Full Auto MCACC)* on page 26 .

Automatic MCACC (Expert)

See *Automatic MCACC (Expert)* on page 62 .

Manual MCACC setup

See *Manual MCACC setup* on page 64 .

PQLS

See *Setting the PQLS function* on page 48 .

Phase Control

See *Better sound using Phase Control* on page 39 .

Full Band Phase Control

VSX-53 only:

See *Better sound using Phase Control and Full Band Phase Control* on page 39 .

Standing Wave

See *Setting the Audio options* on page 50 .

Phase Control Plus

See *Setting the Audio options* on page 50 .

Auto Sound Retriever

See *Setting the Audio options* on page 50 .

ALC (Auto Level Control)

See *Auto playback* on page 37 .

Front Stage Surround Advance

See *Enjoying various types of playback using the listening modes* on page 37 .

Sound Retriever Air

See *Enjoying various types of playback using the listening modes* on page 37 .

Dialog Enhancement

See *Setting the Audio options* on page 50 .

Internet radio

See *Listening to Internet radio stations* on page 42 .

vTuner

See *Listening to Internet radio stations* on page 42 .

Rhapsody

See *Playback with Home Media Gallery* on page 42 .

Sirius Internet Radio

See *Playback with Home Media Gallery* on page 42 .

Pandora

See *Playback with Home Media Gallery* on page 42 .

DLNA

See *About network playback* on page 44 .

AirPlay

See *Using AirPlay on iPod touch, iPhone, iPad, and iTunes* on page 41 .

Wireless LAN

See *Connecting to a wireless LAN* on page 23 .

Playback High Resolution audio file

See *About playable file formats* on page 45 .

Slideshow

See *Playing back photo files stored on a USB memory device* on page 31 .

Bluetooth ADAPTER

See *Bluetooth ADAPTER for Wireless Enjoyment of Music* on page 35 .

ARC (Audio Return Channel)

See *HDMI Setup* on page 47 .

SACD Gain

See *Setting the Audio options* on page 50 .

Auto delay

See *Setting the Audio options* on page 50 .

Height Gain (Dolby Pro Logic IIz Height option)

See *Setting the Audio options* on page 50 .

Virtual Height

See *Setting the Audio options* on page 50 .

Virtual Surround Back

See *Setting the Audio options* on page 50 .

Virtual Depth

See *Setting the Audio options* on page 50 .

Digital Video Converter

See *Setting the Video options* on page 52 .

Pure Cinema

See *Setting the Video options* on page 52 .

Progressive Motion

See *Setting the Video options* on page 52 .

Advanced Video Adjust

See *Setting the Video options* on page 52 .

Auto Power Down

See *The Other Setup menu* on page 73 .

Specifications

Amplifier section

Continuous average power output of 110 watts* per channel, min., at 8 ohms, from 20 Hz to 20 000 Hz with no more than 0.08 % total harmonic distortion.**

Continuous Power Output (20 Hz to 20 kHz, 8 Ω, 0.08 %)	
Front	110 W + 110 W
Center	110 W
Surround	110 W + 110 W
Surround back (Front height/wide)	110 W + 110 W
Continuous Power Output (1 kHz, 6 Ω, 1.0 %)	
Front	150 W + 150 W
Center	150 W
Surround	150 W + 150 W
Surround back (Front height/wide)	150 W + 150 W
Total harmonic distortion	0.06 % (20 Hz to 20 kHz, 100 W + 100 W, 8 Ω)
Guaranteed speaker impedance	16 Ω to 8 Ω, less than 8 Ω to 6 Ω (setting required)

* Measured pursuant to the Federal Trade Commission's Trade Regulation rule on Power Output Claims for Amplifiers

** Measured by Audio Spectrum Analyzer

Audio Section

Input (Sensitivity/Impedance)	
LINE	350 mV/47 kΩ
Output (Level/Impedance)	
REC	335 mV/2.2 kΩ
Signal-to-Noise Ratio (IHF, short circuited, A network)	
LINE	103 dB
Frequency Response	5 Hz to 100 000 Hz \pm 3 dB (Pure Direct Mode)

Tuner Section

Frequency Range (FM)	87.5 MHz to 108 MHz
Antenna Input (FM)	75 Ω unbalanced
Frequency Range (AM)	531 kHz to 1602 kHz
Antenna (AM)	Loop antenna (balanced)

Video Section

Signal level	
Composite Video	1 Vp-p (75 Ω)
Component Video	Y: 1.0 Vp-p (75 Ω), PB/PR: 0.7 Vp-p (75 Ω)
Corresponding maximum resolution	
Component Video	1080p (1125p) (Video convert off)

Digital In/Out Section

HDMI terminal	19-pin (Not DVI)
HDMI output type	5 V, 55 mA
USB terminal	USB2.0 Full Speed (Type A)
iPod terminal	USB, and Video (Composite)
SIRIUS antenna cable	8-pin mini DIN cable
ADAPTER PORT terminal	5 V, 100 mA
WIRELESS LAN ADAPTER terminal	5 V, 600 mA

Integrated Control Section

Control (SR) terminal	ø 3.5 Mini-jack (MONO)
Control (IR) terminal	ø 3.5 Mini-jack (MONO)
IR signal	High Active (High Level: 2.0 V)
12 V Trigger terminal	ø 3.5 Mini-jack (MONO)
12 V Trigger output type	12 V, Total 150 mA
RS-232C cable type	9-pin, cross type, female-female
EXTENSION terminal	5 V, 150 mA

Network Section

LAN terminal	10 BASE-T/100 BASE-TX
--------------------	-----------------------

Miscellaneous

Power requirements	AC 120 V, 60 Hz
Power consumption	570 W
In standby	
.....	0.1 W (HDMI Setup – Control : OFF)
.....	0.3 W (HDMI Setup – Control : ON)
Dimensions	
.....	435 mm (W) x 185.6 mm (H) x 440.3 mm (D) (17 3/16 in. (W) x 7 5/16 in. (H) x 17 3/8 in. (D))
Weight (without package)	
VSX-53	13.9 kg (30.6 lb)
VSX-52	13.7 kg (30.2 lb)

Number of Furnished Parts

MCACC Setup microphone	1
Remote control unit	1
AAA size IEC R03 dry cell batteries	2
iPod cable	1
AM loop antenna	1
FM wire antenna	1
Warranty card	1
Power cord	
CD-ROM (AVNavigator)	
These operating instructions	



Note

- Specifications and the design are subject to possible modifications without notice, due to improvements.
- *This product includes FontAvenue® fonts licensed by NEC Corporation. FontAvenue is a registered trademark of NEC Corporation.*

Preset code list

You should have no problem controlling a component if you find the manufacturer in this list, but please note that there are cases where codes for the manufacturer in the list will not work for the model that you are using. There are also cases where only certain functions may be controllable after assigning the proper preset code.



Important

- We do not guarantee the operations of all the manufacturers and devices listed. Operation may not be possible even if a preset code is entered.
- If you can't find a preset code that matches the component you want to control, you can still teach the remote individual commands from another remote control (see *Programming signals from other remote controls* on page 57).

TV

Pioneer 0004, 0006, 0113, 0115, 0116, 0117, 0119, 0122, 0123

Admiral 0001, 0014

Adventura 0012

Aiwa 0002

Akai 0002, 0100

Albatron 0097

Alleron 0009

America Action 0104

Amtron 0008

Anam 0104

Anam National 0003, 0008

AOC 0004, 0005, 0006, 0100

Apex 0021, 0102, 0106

Audiovox 0008, 0104

Aventura 0103

Axion 0094

Bang & Olufsen 0111

Belcor 0004

Bell & Howell 0001

Benq 0064

Bradford 0008, 0104

Brilliant 0109

Brockwood 0004

Broksonic 0104

Candle 0004, 0006, 0012, 0100

Carnivale 0100

Carver 0101

CCE 0110

Celebrity 0002

Celera 0106

Changhong 0106

Citizen 0004, 0006, 0008, 0100

Clarion 0104

Coby 0056

Colortyme 0004, 0006

Concerto 0004, 0006

Contec 0104

Contec/Cony 0007, 0008

Craig 0008, 0104

Crosley 0081, 0101

Crown 0008, 0104

CTX 0063

Curtis Mathes 0000, 0004, 0006, 0014, 0100, 0101

CXC 0008, 0104

Cytron 0093

Daewoo 0004, 0005, 0006, 0023

Daytron 0004, 0006

Dell 0073

DiamondVision 0096

Dimensia 0000

Disney 0046

Dumont 0004, 0011, 0099

Durabrand 0041, 0103, 0104

Dwin 0014

Electroband 0002

Electrograph 0107

Electrohome 0002, 0003, 0004, 0006

Element 0082

Emerson 0004, 0006, 0007, 0008, 0009, 0023, 0103, 0104

Emprex 0092

Envision 0004, 0006, 0100

Epson 0061

ESA 0103

Fujitsu 0009

Funai 0008, 0009, 0103, 0104

Futuretech 0008, 0104

Gateway 0067, 0107, 0108

GE 0000, 0003, 0004, 0006, 0010, 0016, 0039

GFM 0080, 0084

Gibralter 0004, 0011,

0099, 0100

Goldstar 0004, 0005, 0006, 0007, 0100

Gradiente 0066

Grunpy 0008, 0009, 0104

Haier 0112

Hallmark 0004, 0006

Harman/Kardon 0101

Harvard 0008, 0104

Havermy 0014

Hewlett Packard 0053

Hisense 0069

Hitachi 0004, 0006, 0007

Hyundai 0098

Ilo 0089, 0091

IMA 0008

Infinity 0101

InFocus 0074

Initial 0091

Insignia 0085, 0086

Inteq 0099

Janeil 0012

JBL 0101

JC Penney 0000, 0004, 0005, 0006, 0010

JCB 0002

Jensen 0004, 0006

JVC 0007, 0010, 0044, 5064

Kawasho 0002, 0004, 0006

KEC 0104

Kenwood 0004, 0006, 0100

KLH 0106

Kloss Novabeam 0008, 0012

KTV 0008, 0100, 0104, 0110

LG 0005, 0052, 0078, 0097

Logik 0001

Luxman 0004, 0006

LXI 0000, 0006, 0101, 0102

Magnavox 0004, 0006, 0019, 0020, 0037, 0042, 0100, 0101

Majestic 0001

Marantz 0004, 0006, 0062, 0100, 0101

Matsushita 0105

Maxent 0087, 0107

Megapower 0097

Megatron 0006

Memorex 0001, 0005, 0006, 0041

MGA 0004, 0005, 0006, 0100

Midland 0010, 0011, 0099

Mintek 0091

Mitsubishi 0004, 0005, 0006, 0014, 0045

Monivision 0097

Montgomery Ward 0001

Motorola 0003, 0014

MTC 0004, 0005, 0006, 0100

Multitech 0008, 0104, 0110

NAD 0006, 0102

NEC 0003, 0004, 0005, 0006, 0100

Net-TV 0107

Nikko 0006, 0100

Norcent 0060

Olevia 0048, 0054, 0059

Onwa 0008, 0104

Oppo 0095

Optimus 0105

Optoma 0075

Optonica 0014

Orion 0025

Panasonic 0003, 0010, 0017, 0027, 0105, 0114, 0120, 0121, 0124, 0125

Penney 0100, 0102

Philco 0003, 0004, 0005, 0006, 0007, 0100, 0101

Philips 0003, 0004, 0007, 0019, 0020, 0101

Philips Magnavox 0019, 0100, 0100

Polaroid 0057, 0106

Portland 0004, 0005, 0006

Prima 0065

Princeton 0097

Prism 0010

Proscan 0000

Proton 0004, 0006, 0007

Protron 0055

Proview 0068

Pulsar 0004, 0011, 0099

Quasar 0003, 0010, 0105

Radio Shack 0100, 0104

Radio Shack/Realistic

0000, 0004, 0006, 0007, 0008

RCA 0000, 0003, 0004,

0005, 0006, 0013, 0024, 0035

Realistic 0100, 0104

Runco 0011, 0099, 0100

Sampo 0004, 0006, 0100, 0107

Samsung 0004, 0005, 0006, 0007, 0022, 0032,

0076, 0077, 0083, 0100, 0110

Sansui 0025

Sanyo 0004, 0050

Sceptre 0072

Scotch 0006

Scott 0004, 0006, 0007, 0008, 0009, 0090, 0104

Sears 0000, 0004, 0006, 0009, 0101, 0102, 0103

Sharp 0004, 0006, 0007, 0014, 0033

Sheng Chia 0014

Shogun 0004

Signature 0001

Sony 0002, 0018, 0029,

0030, 0031, 0034

Soundesign 0004, 0006, 0008, 0009, 0104

Squareview 0103

SSS 0004, 0008, 0104

Starlite 0008, 0104

Superscan 0014

Supre-Macy 0012

Supreme 0002

SVA 0088

Sylvania 0004, 0006, 0049, 0079, 0080, 0100,

0101, 0103

Symphonic 0008, 0041, 0103, 0104

Syntax 0054

Syntax-Brilliant 0054

Tandy 0014

Tatung 0003, 0108

Technics 0010, 0105

Techwood 0004, 0006, 0010

Teknika 0001, 0004, 0005, 0006, 0007, 0008,

0009, 0101, 0104

TMK 0004, 0006

TNCi 0099

Toshiba 0026, 0028, 0036, 0038, 0040, 0043,

0102

Vector Research 0100

Vidikron 0101

Vidtech 0004, 0005, 0006

Viewsonic 0058, 0107

Viking 0012

Viore 0089

Vizio 0004, 0070, 0071, 0108

Wards 0000, 0001, 0004, 0005, 0006, 0009, 0100, 0101

Waycon 0102

Westinghouse 0047, 0051

White Westinghouse 0023

Yamaha 0004, 0005,

0006, 0100

Zenith 0001, 0004, 0011, 0015, 0099

DVD

If operations are not possible using the preset codes below, you may be able to conduct operations with the preset codes for the **BD, DVR (BDR, HDR)**.

Pioneer 2014, 2158	Daewoo 2021, 2087	Kenwood 2028, 2068	Rio 2087
Accurian 2092	Denon 2026, 2068	KLH 2070, 2080	Rowa 2071
Advent 2072	Desay 2055	Koss 2024, 2069, 2075	Samsung 2009, 2011, 2015, 2031, 2044, 2068
Aiwa 2012	DiamondVision 2042	Landel 2093	Sansui 2066
Akai 2066	Disney 2022	Lasonic 2085	Sanyo 2066, 2083
Alco 2070	Durabrand 2090	Lennox 2074, 2090	Sharp 2035
Allegro 2087	Emerson 2067, 2082, 2091	LG 2019, 2051, 2061, 2082, 2087	Sherwood 2063
Amphion MediaWorks 2037	Enterprise 2082	Liquid Video 2075	Shinonic 2086
AMW 2037	ESA 2053, 2091	Liteon 2025, 2092	Sonic Blue 2087
Apex 2002, 2018, 2079, 2080	Fisher 2083	Magnavox 2067, 2076, 2091	Sony 2003, 2004, 2010, 2012, 2027, 2046, 2047, 2048
Apple 2058	Funai 2091	Memorex 2066	Sungale 2054
Arrgo 2088	GE 2016, 2077, 2080	Microsoft 2077	Superscan 2067
Aspire 2073	GF 2043	Mintek 2038, 2080, 2086	Sylvania 2023, 2067, 2091
Astar 2052	Go Video 2087	Mintek 2038, 2080, 2086	Symphonic 2023
Audiovox 2070	Gradiente 2068	Mitsubishi 2020	Teac 2070
Axion 2040	Greenhill 2080	Nesa 2080	Technics 2068
Bang & Olufsen 2081	Haier 2094	Next Base 2093	Theta Digital 2078
Blaupunkt 2080	Harman/Kardon 2030, 2084	Nexxtech 2056	Toshiba 2001, 2006, 2049, 2066, 2076
Blue Parade 2078	Hitachi 2011	Onkyo 2076	Trutech 2000
Boston 2059	Hiteker 2079	Oppo 2041, 2057	Urban Concepts 2076
Broksonic 2066	iLive 2062	Oritron 2069, 2075	US Logic 2086
California Audio Labs 2068	Ilo 2038	Panasonic 2005, 2007, 2017, 2032, 2033, 2050, 2068, 2076	Venturer 2070
CambridgeSoundWorks 2065	Initial 2038, 2080	Philips 2045, 2076	Xbox 2077
CineVision 2087	Insignia 2036, 2064, 2091	Proceed 2079	Yamaha 2005, 2068
Coby 2029	Integra 2078	Proscan 2077	Zenith 2019, 2076, 2082, 2087
Curtis Mathes 2089	iSymphony 2060	Qwestar 2069	
CyberHome 2000, 2088	JBL 2084	RCA 2008, 2016, 2070, 2077, 2078, 2080	
Cytron 2039	JVC 2013	Regent 2074	
	Kawasaki 2070		

BD

If operations are not possible using the preset codes below, you may be able to conduct operations with the preset codes for the **DVD, DVR (BDR, HDR)**.

Pioneer 2159, 2160	Kenwood 2044	Panasonic 2114, 2115, 2116	Sony 2120, 2121, 2122, 2129
Denon 2147, 2148, 2149	LG 2123, 2124	Philips 2117	Toshiba 2125, 2099
Hitachi 2144, 2145, 2146	Marantz 2139, 2140	Samsung 2119	Yamaha 2134, 2135, 2136
JVC 2127, 2128, 2130, 2131, 2132, 2133	Mitsubishi 2137, 2138	Sharp 2141, 2142, 2143	
	Onkyo 2126		

DVR (BDR, HDR)

If operations are not possible using the preset codes below, you may be able to conduct operations with the preset codes for the **DVD, BD**.

Pioneer 2103, 2150, 2151, 2152, 2153, 2154, 2155, 2156, 2157	Panasonic 2100, 2106	Sony 2105, 2108, 2109, 2110, 2113
	Sharp 2104, 2112	Toshiba 2111

VCR

Pioneer 1035	Emerson 1003, 1004, 1005	Linksys 1017	Proscan 1030
ABS 1017	Expressvu 1029	Lloyd's 1005	Pulsar 1018
Adventura 1005	Fisher 1001	LXI 1003	Quarter 1001
Aiwa 1005	Fuji 1004	Magnavox 1004, 1018	Quartz 1001
Alienware 1017	Funai 1005	Magnin 1003	Quasar 1004
American High 1004	Garrard 1005	Marantz 1000, 1001, 1004	Radio Shack 1003
Asha 1002	Gateway 1017	Marta 1003	Radio Shack/Realistic 1001, 1002, 1003, 1004, 1005
Audio Dynamics 1000	GE 1002, 1004	Matsushita 1004	Radix 1003
Audiovox 1003	GOI 1029	Media Center PC 1017	Randex 1003
Bang & Olufsen 1032	Goldstar 1000, 1003	MEI 1004	RCA 1002, 1004, 1007, 1016, 1020, 1022, 1030, 1031
Beaumarck 1002	Gradiente 1005	Memorex 1001, 1002, 1003, 1004, 1005, 1018, 1019	Realistic 1001, 1002, 1003, 1004, 1005
Bell & Howell 1001	Harley Davidson 1005	Headquarter 1001	ReplayTV 1026
Calix 1003	Harman/Kardon 1000	Hewlett Packard 1017	Ricavision 1017
Candle 1002, 1003	Headquarter 1001	HNS 1016	Runco 1018
Canon 1004	Howard Computers 1017	HP 1017	Samsung 1002, 1016, 1022, 1024
Citizen 1002, 1003	HTS 1029	HP 1017	Sanky 1018
Colortyme 1000	Hughes Network Systems 1016, 1020, 1022, 1023, 1024	HP 1017	Sansui 1014, 1019
Craig 1002, 1003	Humax 1016, 1020	HP 1017	Sanyo 1001, 1002
Curtis Mathes 1000, 1002, 1004	Hush 1017	iBUYPOWER 1017	Sears 1001, 1003, 1004
Cybernex 1002	iBUYPOWER 1017	Instant Replay 1004	Sharp 1012
CyberPower 1017	Dish Network 1029	JC Penney 1000, 1001, 1002, 1003, 1004	Shogun 1002
Daewoo 1005	Dishpro 1029	JCL 1004	Singer 1004
DBX 1000	Durabrand 1018	JVC 1000, 1001, 1020, 1029	Sonic Blue 1026
Dell 1017	Dynatech 1005	JVC 1000, 1001, 1020, 1029	Sony 1006, 1009, 1017, 1021
DIRECTV 1016, 1020, 1022, 1023, 1024, 1027, 1030, 1031	Echostar 1029	Kenwood 1000, 1001	Stack 1017
Dish Network 1029	Electrohome 1003	Kodak 1003, 1004	STS 1004
Dishpro 1029	Electrohome 1003	LG 1003	Sylvania 1004, 1005
Durabrand 1018	Electrophonic 1003		Symphonic 1005
Dynatech 1005			Systemax 1017
Echostar 1029			
Electrohome 1003			
Electrophonic 1003			

Tagar Systems 1017
Tandy 1001
Tashiko 1003
Teac 1005
Technics 1004
Teknika 1003, 1004, 1005

Tivo 1016, 1020, 1021, 1022, 1025
TMK 1002
Toshiba 1015, 1017, 1028
Totevision 1002, 1003
Touch 1017

UltimateTV 1031
Unitech 1002
Vector Research 1000
Video Concepts 1000
Videoseonic 1002
Viewsonic 1017
Voodoo 1017

Wards 1002, 1003, 1004, 1005
Yamaha 1000, 1001
Zenith 1013, 1018
ZT Group 1017

Satellite Set Top Box

Pioneer 0126, 6097, 6098, 6145
ADB 6035, 6001
Akai 6102
Alba 6005, 6013, 6011
Allsat 6102
Alltech 6011
Amstrad 6033, 6030, 6044
Anttron 6013
Asat 6102
Austar 6000, 6045
BELL 6160
Bell ExpressVu 6002, 6003
British Sky Broadcasting 6030
Canal 6105
Chaparral 6034
CNS 6001
Coolsat 6021
Crossdigital 6043
Digenius 6104
Digiwave 6053
DirecTV 6070, 6110, 6111, 6062, 6063, 6113, 6008, 6038, 6054, 6069, 6060, 6059, 6043, 6018, 6114, 6115, 6116, 6093
Dish Network System 6002, 6089, 6003, 6004
Dishpro 6002, 6089, 6004
DX Antenna 6140
E Aichi 6141

EchoStar 6002, 6089, 6036, 6005, 6003, 6004, 6146
Expressvu 6002, 6004
Fujitsu 6133, 6134, 6135
Fortec Star 6123, 6023
Fresat 6014
Funai 6070
GE 6111
General Instrument 6032
GOI 6002, 6004
Grundig 6007, 6030
Hirschmann 6033
Hisense 6020
Hitachi 6038, 6049, 6132
Houston 6002
HTS 6002, 6004
Hughes Network Systems 6113, 6038, 6054, 6114, 6115, 6116
Hyundai 6016
iLo 6020
Innova 6059
Jerrold 6032, 6128, 6149, 6150, 6151, 6152, 6153, 6154, 6155, 6156, 6157
JVC 6002, 6003, 6004
Kathrein 6096
Lava 6053
LG 6047, 6018
Marantz 6102
McIntosh 6032
Mitsubishi 6038
Motorola 6032, 6042
NEC 6050, 6131
Netsat 6059

Next Level 6032
nfusion 6015
Nokia 6025, 6026, 6118, 6119, 6121
Pace 6035, 6005, 6030, 6031
Panarex 6016
Panasonic 6008, 6009, 6030, 6136, 6137, 6138
Pansat 6016, 6022
Philips 6002, 6113, 6038, 6054, 6060, 6059, 6102, 6103, 6030, 6114
Primestar 6032, 6147
Proscan 6110, 6111
Proton 6020
RadioShack 6002, 6111, 6032
Radix 6036
RCA 6002, 6110, 6111, 6113, 6109, 6061, 6114, 6142, 6144, 6148
SA 6124, 6126, 6158, 6159
Saba 6014
Sagem 6041, 6120
Samsung 6070, 6113, 6091, 6043, 6017, 6114, 6093
Sanyo 6046
Sat Cruiser 6015
Schwaiger 6066
SEI 6139
Siemens 6007, 6036
SKY 6042, 6059, 6030, 6031
SM Electronic 6011

Smart 6051
Sonicview 6055, 6107
Sony 6062, 6063, 6030, 6143
Star Choice 6032
Star Trak 6032
TechniSat 6033
Thomson 6110, 6111, 6014
Tivo 6113, 6114, 6115, 6116
Toshiba 6038, 6054, 6039, 6130
TPS 6041
Triasat 6033
Ultrasat 6021
US Digital 6020
USDTV 6020
ViewSat 6048
Voom 6032
Zehnder 6101
Zenith 6042, 6069, 6037, 6125, 6127, 6129

Satellite Set Top Box (SAT/PVR Combination)

Pioneer 0126, 0128
Bell ExpressVu 6002, 6003
DirecTV 6070, 6110, 6062, 6113, 6060, 6059, 6114, 6115, 6116

Dish Network System 6002, 6089
Dishpro 6002, 6089
EchoStar 6002, 6089, 6003
Expressvu 6002

Hughes Network Systems 6113, 6114, 6115, 6116
JVC 6003
Motorola 6032
Philips 6113, 6114
Proscan 6110

Samsung 6114
Sonicview 6055, 6107
Sony 6062
Star Choice 6032
Tivo 6113, 6114, 6115, 6116

Cable Set Top Box

Pioneer 6028, 6029, 6095, 6099
ABC 6122
Accuphase 6122
Amino 6077, 6078
Auna 6082
BCC 6072
Bell & Howell 6122
Bright House 6074, 6029
Cable One 6074, 6029
Cablevision 6074, 6029
Charter 6074, 6029, 6058
Cisco 6029, 6028, 6083
Comcast 6074, 6029, 1982
Cox 6074, 6029
Digeo 6029, 6058

Director 6073
Emerson 6122
Fosgate 6072
General Instrument 6073, 6072, 6122
Homecast 6024
i3 Micro 6077
Insight 6074, 6073, 6029
Jebsee 6122
Jerrold 6073, 6072, 6122
Knology 6029
Macab 6040
Mediacom 6074, 6029
Memorex 6112
Motorola 6074, 6073, 6072, 6029, 6122, 6094
MTS 6094

Myrio 6077, 6078
Noos 6040
Pace 6074, 6029, 6028, 6106, 6083
Panasonic 6112, 6083
Paragon 6112
Penney 6112
Philips 6012
Pulsar 6112
Quasar 6112
Regal 6072
Rogers 6029
Runco 6112
Samsung 6095
Scientific Atlanta 6029, 6028, 6027, 6112
Sejin 6077

Shaw 6074
Starcom 6122
Stargate 6122
Suddenlink 6074, 6029
Supercable 6072
Time Warner 6074, 6029, 6058
Tivo 6076
Toshiba 6112
United Cable 6072, 6122
US Electronics 6072
Videoway 6112
Zenith 6112

Cable Set Top Box (Cable/PVR Combination)

Pioneer 0127, 6029
Amino 6078
Bright House 6074, 6029
Cable One 6074, 6029
Cablevision 6074, 6029
Charter 6074, 6029, 6058
Cisco 6029, 6083

Comcast 6074, 6029, 6083, 6076
Cox 6074, 6029
Digeo 6081, 6058
Homecast 6024
Insight 6074, 6029
Knology 6029

Mediacom 6074, 6029
Motorola 6074, 6081
Myrio 6078
Pace 6029
Panasonic 6083
Rogers 6029
Scientific Atlanta 6029

Shaw 6074
Suddenlink 6074, 6029
Supercable 6072
Time Warner 6074, 6029, 6058
Tivo 6076

CD (SACD)

Pioneer 5065, 5066

AKAI 5043

Asuka 5045

Denon 5019

Fisher 5048

Goldstar 5040

Hitachi 5042

Kenwood 5020, 5021,

5031

Luxman 5049

Marantz 5033

Onkyo 5017, 5018, 5030,

5050

Panasonic 5036

Philips 5022, 5032, 5044

RCA 5013, 5029

Roadstar 5052

Sharp 5051

Sony 5012, 5023, 5026,

5027, 5028, 5039

TEAC 5015, 5016, 5034,

5035, 5037

Technics 5041

Victor 5014

Yamaha 5024, 5025,

5038, 5046, 5047

CD-R

Pioneer 5067

Philips 5054

Yamaha 5055

Cassete Deck

Pioneer 5058, 5059, 5070

Digital Tape

Pioneer 5069

MD

Pioneer 5068

To register your product, find the nearest authorized service location, to purchase replacement parts, operating instructions, or accessories, please go to one of following URLs :

Pour enregistrer votre produit, trouver le service après-vente agréé le plus proche et pour acheter des pièces de rechange, des modes d'emploi ou des accessoires, reportez-vous aux URL suivantes :

In the USA/Aux Etats-Unis

<http://www.pioneerelectronics.com>

In Canada/Aux Canada

<http://www.pioneerelectronics.ca>

S018_B1_EnFr

PIONEER CORPORATION

1-1, Shin-ogura, Saiwai-ku, Kawasaki-shi, Kanagawa 212-0031, Japan

PIONEER ELECTRONICS (USA) INC.

P.O. BOX 1540, Long Beach, California 90801-1540, U.S.A. TEL: (800) 421-1404

PIONEER ELECTRONICS OF CANADA, INC.

340 Ferrier Street, Unit 2, Markham, Ontario L3R 2Z5, Canada TEL: 1-877-283-5901, 905-479-4411

PIONEER EUROPE NV

Haven 1087, Keetberglaan 1, B-9120 Melsele, Belgium TEL: 03/570.05.11

PIONEER ELECTRONICS ASIACENTRE PTE. LTD.

253 Alexandra Road, #04-01, Singapore 159936 TEL: 65-6472-7555

PIONEER ELECTRONICS AUSTRALIA PTY. LTD.

5 Arco Lane, Heatherton, Victoria, 3202, Australia, TEL: (03) 9586-6300

PIONEER ELECTRONICS DE MEXICO S.A. DE C.V.

Bldv.Manuel Avila Camacho 138 10 piso Col.Lomas de Chapultepec, Mexico, D.F. 11000 TEL: 55-9178-4270

K002_B3_En

Register Your Product on

<http://www.pioneerelectronics.com> (US)

<http://www.pioneerelectronics.ca> (Canada)

© 2011 PIONEER CORPORATION.

All rights reserved.

<ARB7454-A>

Printed in